

VS.80_135
IT

Elettropompa sommergibile di robusta costruzione fabbricata completamente in ghisa. Camera olio interposta tra gruppo motore e gruppo pompa. Doppia tenuta meccanica, entrambe interne alla camera olio, non a diretto contatto con il liquido pompato e protette da un anello V-ring posizionato dietro alla girante.

EN

Robust construction submersible pump completely made in cast iron, with oil chamber interposed between motor unit and pump unit. Mechanical seals inside the oil chamber not in direct contact with the pumped liquid and protected by a V-Ring positioned on the back of the impeller.

FR

Pompe submersible de construction robuste entièrement en fonte, avec chambre à huile intercalée entre le moteur et le groupe pompe. Les garnitures mécaniques à l'intérieur de la chambre d'huile ne sont pas en contact direct avec le liquide pompé et sont protégées par un V-Ring placé à l'arrière de la roue.

ES

Bomba sumergible de construcción robusta realizada completamente en hierro fundido, con cámara de aceite interpuesta entre la unidad del motor y la unidad de la bomba. Sellos mecánicos dentro de la cámara de aceite que no están en contacto directo con el líquido bombeado y están protegidos por un V-Ring colocado en la parte posterior del impulsor.

VS.80_173
IT

Elettropompa sommergibile di robusta costruzione fabbricata completamente in ghisa, con camera olio interposta tra gruppo motore e gruppo pompa. Tenute meccaniche in camera olio non a diretto contatto del liquido pompato e protette da un anello di tenuta radiale con bussola in AISI 316 posizionato dietro alla girante.

EN

Compact and solid construction submersible pump completely made in cast iron, with oil chamber interposed between motor unit and pump unit. Mechanical seals inside the oil chamber not in direct contact with the pumped liquid and protected by a lip seal ring with AISI 316 sleeve, positioned on the back of the impeller.

FR

Pompe submersible compacte entièrement réalisée en fonte, avec chambre à huile intercalée entre le groupe moteur et le groupe pompe. Des garnitures mécaniques isolées dans la chambre d'huile ne sont pas en contact direct avec le liquide pompé et protégées par un anneau d'étanchéité avec manchon AISI 316, positionnées à l'arrière de la roue.

ES

Bomba sumergible compacta hecha completamente de hierro fundido, con cámara de aceite interpuesta entre la unidad del motor y la unidad de la bomba. Sellos mecánicos en la cámara de aceite que no están en contacto directo con el líquido bombeado y protegidos por un corteo con un casquillo hecho de AISI 316 colocado detrás del impulsor.

VS.80_135

VS.80_173

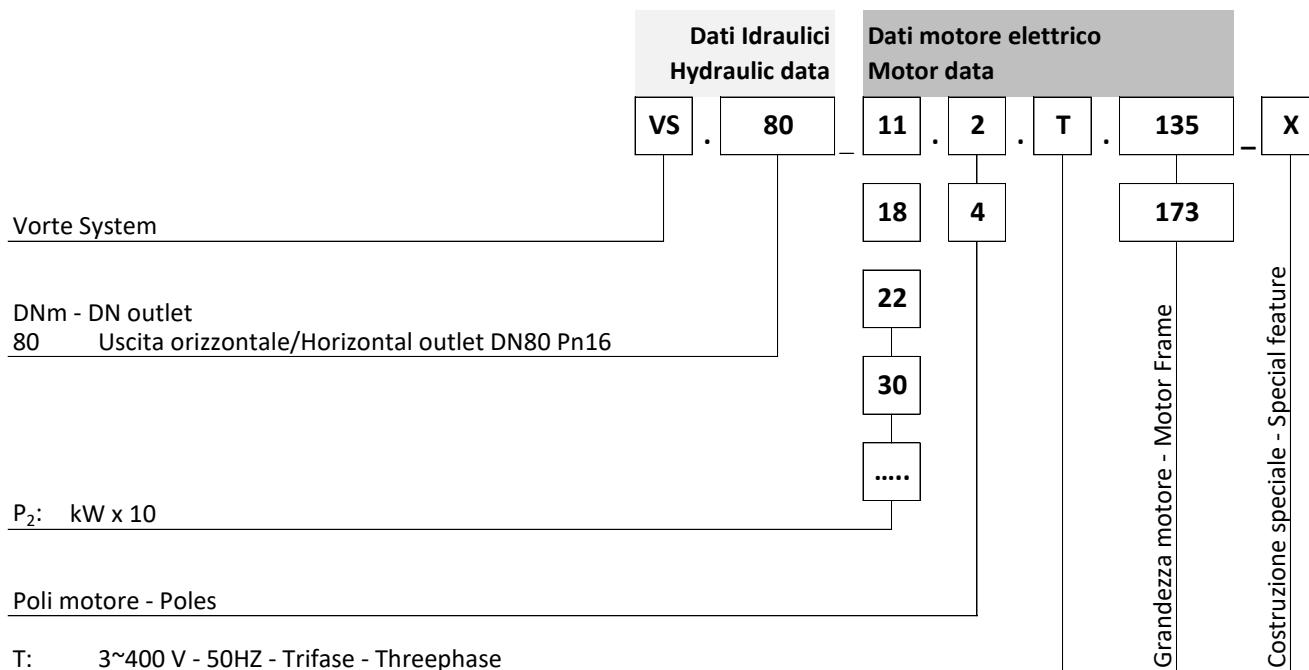
IDENTIFICAZIONE - IDENTIFICATION

LISTA MODELLI - RANGE OF PRODUCTS

Grandezza Motore Motor Frame	Poles	Alimentazione Power supply	P ₂ [kW]	Modelli Models	Avviamento Starting	Cavo alimentazione / segnali Power / signals cable	
						[m]	Type
135	4	3ph	1,1	VS.80_11.4T_135	D.O.L.	10	H07RN-F 4G1,5 / H07RN8-F 7G1,5
			1,5	VS.80_15.4T_135	D.O.L.	10	H07RN-F 4G1,5 / H07RN8-F 7G1,5
			2,2	VS.80_22.4T_135	D.O.L.	10	H07RN-F 4G1,5 / H07RN8-F 7G1,5
	2		2,2	VS.80_22.2T_135	D.O.L.	10	H07RN-F 4G1,5 / H07RN8-F 7G1,5
			3,0	VS.80_30.2T_135	D.O.L.	10	H07RN-F 4G1,5 / H07RN8-F 7G1,5
173	4	3ph	3,0	VS.80_30.4T_173	D.O.L.	10	H07RN-F 4G2,5 / + H07RN-F 4G1,5
			4,0	VS.80_40.4T_173	D.O.L.	10	H07RN-F 4G2,5 / + H07RN-F 4G1,5
	2	3ph	3,7	VS.80_37.2T_173	D.O.L.	10	H07RN-F 4G2,5 / + H07RN-F 4G1,5
			5,5	VS.80_55.2T_173	D.O.L.	10	H07RN-F 4G2,5 / + H07RN-F 4G1,5
					S.D.	10	H07RN8-F 7G1,5 / + H07RN-F 4G1,5
			7,5	VS.80_75.2T_173	D.O.L.	10	H07RN-F 4G2,5 / + H07RN-F 4G1,5
					S.D.	10	H07RN8-F 7G1,5 / + H07RN-F 4G1,5

Caratteristiche costruttive - construction features

Anello per movimentazione pompa

Shackel to handle the pump
Manille pour lever la pompe
Grillete para levantar la bomba

Pastiglia termica

Built in Thermal protector
Protecteur thermique intégré
Protector térmico incorporado

10 m - H07RN-F

OPTIONAL

Sonda Olio
Oil Probe
Sonde d'huile

Viti Screws Des vis Empulgueras	Quality A2
--	---------------

O-RINGS	NBR
---------	-----

DNm: DN80 PN16

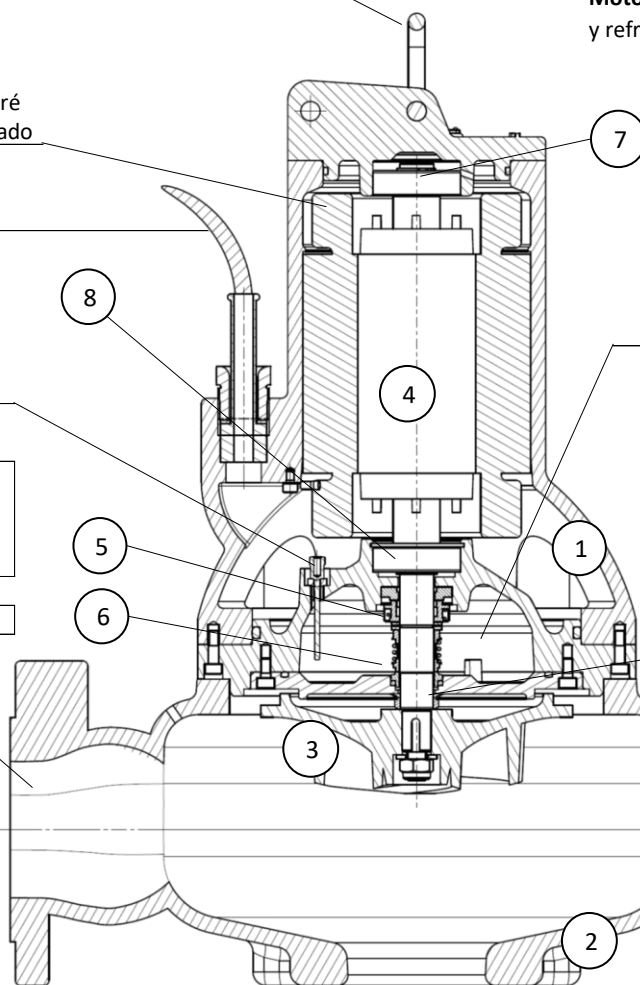

Motore asincrono in classe di isolamento F (155°C), a secco e raffreddato dal liquido circostante;

Asynchronous dry motor, insulation class F(155°C), cooled by the surrounding liquid;

Moteur asynchrone, classe d'isolation F (155°C), sec et refroidi par le liquide environnant;

Motor asíncrono, aislamiento clase F (155 ° C), seco y refrigerado por el líquido que rodea.

Camera olio per il raffreddamento e la lubrificazione delle tenute meccaniche;
Oil chamber for cooling and lubrication of mechanical seals;
Chambre d'huile pour le refroidissement et la lubrification des garnitures
Cámara de aceite para la refrigeración y la lubricación de los sellos mecánicos.

V-Ring	NBR (Viton)
--------	----------------

Girante arretrata con ampio passaggio libero
Backward impeller with large free passage

Roue arrière avec grand passage libre

Impulsor hacia atrás con gran paso libre.

NR.	DESCRIPTION	MATERIAL
1	Gruppo motore	Ghisa
	Motor group	Cast iron
	Groupe moteur	Fer de fonte
	Unidad de motor	Hierro
2	Corpo idraulico	Ghisa
	Pump Housing	Cast iron
	Corps de la pompe	Fer de fonte
	Cuerpo hidráulico	Hierro
3	Girante	Ghisa
	Impeller	Cast iron
	Roue	Fer de fonte
	Impulsor	Hierro
4	Albero motore	Acciaio
	Shaft	Steel
	Arbre moteur	Acier
	Eje del motor	Acero

NR.	DESCRIPTION	MATERIAL
5	Tenuta mecc. superiore	Carbon graphite / Al-Oxide
	Upper mech. seal	
6	Haut garniture mécan.	NBR
	Sello mecánico superior	
7	Tenuta mecc. Inferiore	SiC / SiC
	Lower mech. seal	
8	Haut garniture mécan.	NBR
	Sello mecánico inferior	
7	Cuscinetto superiore	
	Top bearing	6302 2RS1
8	Roulement supérieur	
	Cojinete superior	
7	Cuscinetto inferiore	
	Lower bearing	6304 2RS1
8	Roulement inférieur	
	Cojinete inferior	

Caratteristiche costruttive - construction data

Costruzione Motore - Motor Frame	135		
Grado di protezione IP - IP protection	IP x8		
Classe di Isolamento - Insulation Class	F (155°C)		
Tipo di servizio - Service type	S1 Continuous / S3 Intermittent		
Avvolgimento statore - Stator winding	3~PH - Threephase		
		Y / Δ	
	[V]	3~400/230	
<input type="checkbox"/> Protezione motore - Motor Protection	Optional		
<input type="radio"/>	Bimetallico - Bimetal disc	<input checked="" type="checkbox"/>	130°C
<input type="radio"/>	Solo su richiesta - on request only	PT100	<input type="checkbox"/>
<input type="radio"/>	Solo su richiesta - on request only	PTC	<input type="checkbox"/>
Raffreddamento - Cooling	Dal liquido circostante - By surrounding fluid		
Camera olio - Oil chamber	Si - Yes		
Protezione Tenuta - Leakage protection	Optional		
Tipo girante - Impeller	Vortex		
DN mandata - Discharge	DN 80 Pn16	Orizzontale - Horizontal	
Controflangia filettata - Threaded counterflange	Si - Yes	G 3"	
DN aspirazione / Suction	[mm]	DN 80	
Tipo di vernice e spessore - Paint type and thickness	Standard	Vernice all'acqua - Water paint / 30μm Opaco Nero - Opaque Black	
	Optional	Epossidica - Epoxy coating / 80μm RAL 7015 - Grigio - Grey	

Limiti di utilizzo - Operating Limits

Temperatura massima liquido - Pumped fluid max temperature	[°C]	≤ 40
Densità liquido - Density	[Kg/dm ³]	~ 1
Viscosità - Viscosity	[mm ² /s]	~ 1
Contenuto di cloruri - Chlorides content	[mg/l]	< 200
PH liquido pompato - PH value		6 ÷ 13.5
Max. prof. Immersione - Max. Immersion depth	[m]	20
Max. contenuto solidi abrasivi - Max. abrasive solid content	[g/l]	< 0,1

Corretta rotazione della girante
Rotation of the impeller

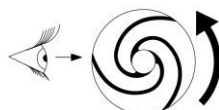



Tipo di pompa - Pump model
VS.80_22.4.135

Poles: 4 Hz: 50
r.p.m. 1500

Girante Impeller
Mandata Discharge
VORTEX
DN 80 - G 3"

Serie 1

CURVA CARATTERISTICA - PERFORMANCE CURVE

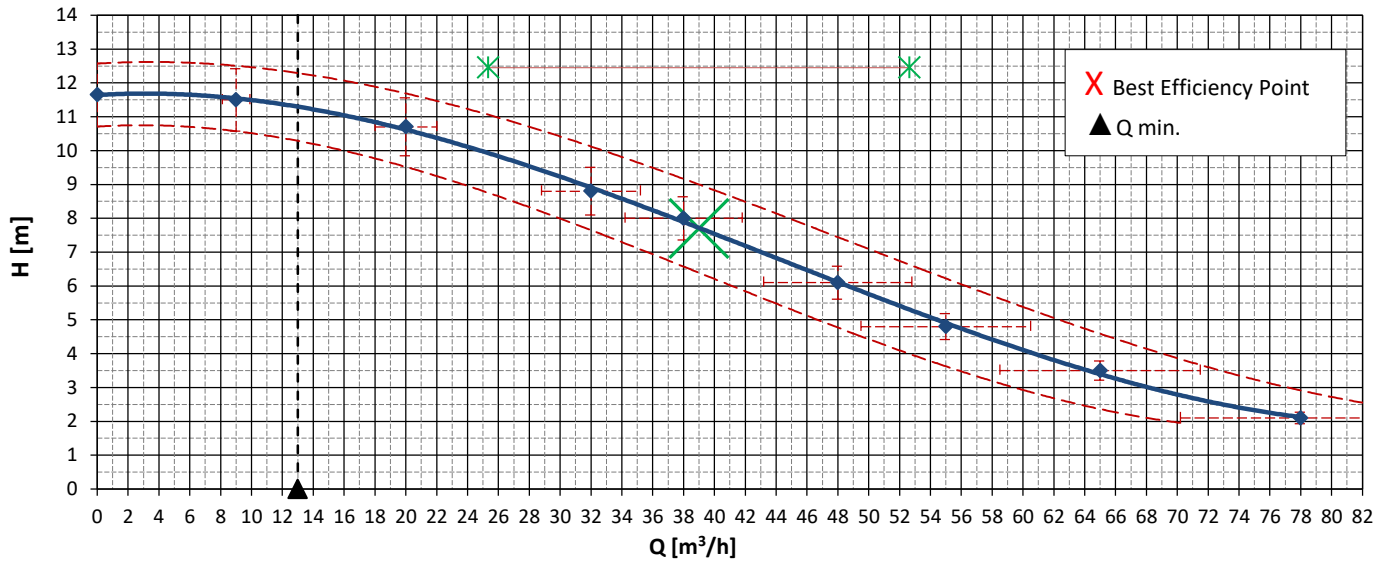

POTENZA ALL'ALBERO - SHAFT POWER

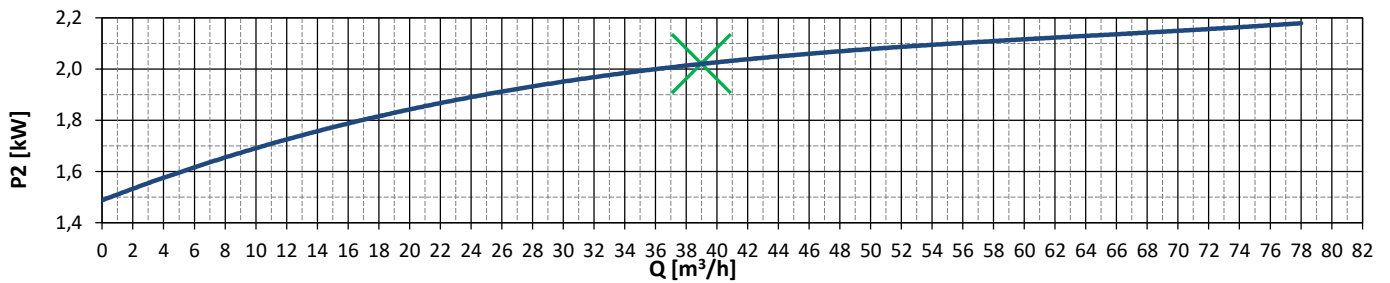

RENDIMENTO IDRAULICO - HYDRAULIC EFFICIENCY

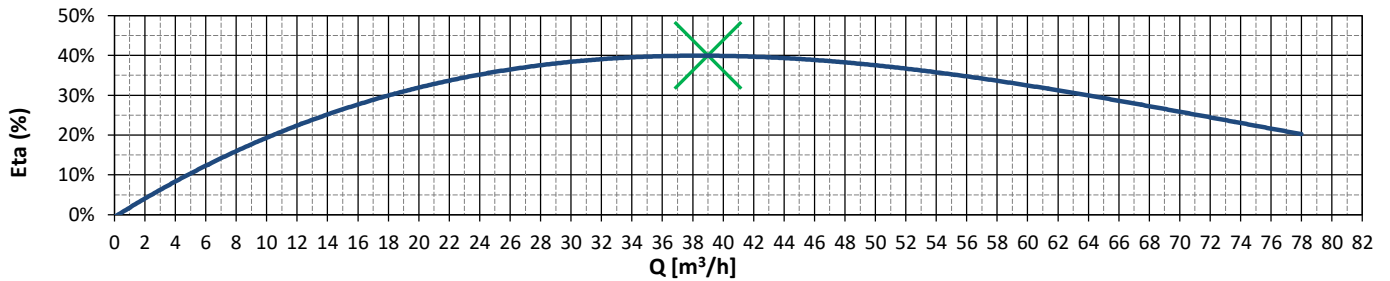

FLOW (Q)	l/min	0,0	150,0	333,3	533,3	633,3	800,0	916,7	1083,3	1300,0			
	l/s	0,0	2,5	5,6	8,9	10,6	13,3	15,3	18,1	21,7			
	m³/h	0,0	9,0	20,0	32,0	38,0	48,0	55,0	65,0	78,0			
HEAD (H)	m	11,7	11,5	10,7	8,8	8,0	6,1	4,8	3,5	2,1			

Dati pompa / Pump data

Potenza nominale Nominal power	(P _n)	[KW]	2,2
Potenza all'albero Shaft power	(P ₂)	[KW]	2,2
Potenza assorbita Supply Power	(P ₁)	[KW]	2,9
Fattore di potenza Power Factor	Cosφ		0,81

Alimentazione Power supply	[V]	3~400-50Hz
Avviamento Starting		D.O.L.
Corrente Nominale Rated current	[A]	5,2
Corrente di spunto Starting current	[A]	27,0

Model T

Passaggio libero Free Passage	[mm]	Ø 80
Diametro girante Impeller diameter	[mm]	Ø 219
Peso pompa Weight	[Kg]	76,0

Galleggiante Float level switch		No
Cavo Cable		4G1,5
Nr. Avviamenti / ora Nr. Start per hour		20

In accordo con: ISO 9906:2012 - Grade 3B (section 4.4.2)
In accordance to:

Curve per liquidi con densità/curve established for liquid with density
1Kg/dm3 - viscosità/viscosity 1 mm2/s - temperatura/temperature 20°C

Dimensioni d'ingombro - overall dimensions

S Installazione mobile - Installation mobile - Installation mobile - Instalación móvil

Dimensione imballo Packaging dimensions		
A	B	C
750	450	390

Misure - Measures [mm]		
A	B	C
750	450	390

FC Con piede di accoppiamento - With foot coupling - Avec pied d'assise - Con pie de acoplamiento

8FC00004	
1	Supporto tubi guida da 1"1/2 1"1/2 guide rails bracket
2	Piede Verticale 3" Vertical foot - 3"out
3	Slitta completa Sliding bracket complete
4	Esclusi dalla fornitura Not supplied



D	550
E	600
F	400

ACCESSORI - ACCESSORIES - ACCESORIES - ACCESORIOS

Descrizione - Description - Description - Descripción			Codice Code
FC		- Dispositivo di accoppiamento DN 80 - DN 80 Coupling device - Dispositif de couplage DN 80 - Dispositivo de acoplamiento DN 80	8FC000004
STD		- Cavalletto di sostegno in acciaio inox - Stainless steel support stand - Support en acier inoxydable - Soporte de acero inoxidable.	8FC000005
AT 80		- Adattatore per dispositivo di accoppiamento della concorrenza - Adapter for competitors foot coupling devices - Adaptateur pour pied d'assise du concurrent - Adaptador para dispositivo de acoplamiento de competidor	2SB000004
		- Catena ferro zincato - galvanized Iron - fer galvanisé - hierro galvanizado - Chain - Chaîne - Cadena Acciaio - Stainless steel - acier inox - acero inox	2SC000019 2SC000032
FBV		- Valvola di ritegno a palla flangiata - Flanged valve - Vanne à bride - Válvula de bola de retención con bridas	DN 80 PN10 4BV000007
HF		- Regolatore di livello per acque reflue - Level switch for sewage - Interrupteur de niveau pour eaux usées - Interruptor de nivel para aguas residuales	[10 mt] 3CS000007
SHELL		- Contrappeso SHELL per galleggiante - Counterweight SHELL for level switch - Cotrepoids SHELL pour interrupteur de niveau - Contrapeso para interruptor de nivel	3CS000021

SELEZIONE QUADRO DI CONTROLLO - CONTROL PANEL SELECTION

	Pole	Pump	Alim. [V]	P ₂ [KW]	In [A]	Avv.
135	4	VS.80_11.4T.135	3~400	1,1	3	DOL
		VS.80_15.4T.135	3~400	1,5	3,5	DOL
		VS.80_22.4T.135	3~400	2,2	5,2	DOL
	2	VS.80_22.2T.135	3~400	2,2	5,3	DOL
		VS.80_30.2T.135	3~400	3,0	6,8	DOL
173	4	VS.80_30.4T.173	3~400	3,0	7,0	DOL
		VS.80_40.4T.173	3~400	4,0	8,1	DOL
	2	VS.80_37.2T.173	3~400	3,7	10,0	DOL
		VS.80_55.2T.173	3~400	5,5	12,5	DOL
		VS.80_55.2T.173.SD	3~400	5,5	12,5	S/D
		VS.80_75.2T.173	3~400	7,5	16,8	DOL
		VS.80_75.2T.173.SD	3~400	7,5	16,8	S/D

 - ECH - ELECTROMECHANICAL								 - ECL - ELECTRONIC							
1 PUMP				2 PUMPS				1 PUMP				2 PUMPS			
ECH1.T-7 5EC000005	ECH1.T-14 5EC000007	ECH1.T.S/D_20 5EC000106	ECH2.T-7 5EC000029	ECH21.T-14 5EC000031	ECH2.T.S/D_20 5EC000108	ECH1.T-15 5EC000083	ECH1.T-24 5EC000086	ECL2.T-15 5EC000084	ECH2.T-24 5EC000087						
•			•			•				•					
•			•			•				•					
•			•			•				•					
•			•			•				•					
•			•			•				•					
	•			•			•				•				
	•			•			•				•				
	•			•			•				•				
	•			•			•				•				
		•			•							•			
		•			•							•			