



INDUSTRIAL AUTOMATION

www.enertronicasanterno.it



Giving energy more value

INDUSTRIAL AUTOMATION

All figures, dimensions, weights and data are indicative.
For a detailed dimensioning please call Enertronica Santerno S.p.A. pre-sales technical office.
This catalogue is subject to changes without prior notice.
No liability shall be accepted for printing errors.



Global footprint

For 50 years, Enertronica Santerno S.p.A. has been a leading company in the manufacture of industrial automation inverters and softstarters. Based in Castel Guelfo, Italy, with branches and commercial offices in Brazil, Spain, Chile, South Africa, USA, Panama and Colombia. Santerno has a worldwide sales network of over 50 distributors also providing after-sales service. During the last 5 years Santerno inverters have been installed in over 100 countries worldwide.

Afghanistan	Chile	Germany	Kazakhstan
Albania	China	Ghana	Kenya
Algeria	Colombia	Greece	Kuwait
Argentina	Cyprus	Guatemala	Kyrgyzstan
Armenia	Czech Republic	Guinea	Latvia
Australia	Denmark	Hungary	Lesotho
Austria	Dominican Republic	India	Liechtenstein
Bangladesh	Ecuador	Indonesia	Lithuania
Belarus	Egypt	Iraq	Malaysia
Belgium	Estonia	Ireland	Mali
Bhutan	Ethiopia	Israel	Malta
Brazil	France	Italy	Mexico
Canada	Gambia	Jordan	Morocco



LEGEND:

○ Distributors

⊘ Direct branches

Namibia
 Netherlands
 New Zeland
 Nigeria
 Norway
 Oman
 Pakistan
 Paraguay
 Peru
 Philippines
 Panama
 Poland
 Portugal

Qatar
 Republic of Korea
 Moldavian Republic
 Romania
 Russian Federation
 San Marino
 Saudi Arabia
 Senegal
 Serbia
 Singapore
 Slovakia
 Slovenia
 Sud Africa
 Spain

Sri Lanka
 Sweden
 Swiss
 Arab Republic of Syria
 Tajikistan
 Taiwan
 Thailand
 Tunisia
 Turkey
 Ukraine
 United Arab Emirates
 UK
 United Republic of Tanzania

United States of America
 Uruguay
 Uzbekistan
 Venezuela
 Viet Nam
 Taiwan
 Tajikistan
 Zambia



CONTENTS

Santerno global footprint	2
SINUS B	6
SINUS J	8
SINUS H	12
SINUS S	16
SINUS PENTA	20
PENTA MARINE	52
SINUS PENTA XT	54
SINUS PENTA IN CABINET	58
SINUS PENTA BOX IP54	64
IRIS BLUE	66
SOLARDRIVE PLUS/BOX/CABINET	72
Inductors	74
Braking units and resistors	76
Optional boards	78
ASA 4.0 - SOFT-STARTER	88
ASAMV - SOFT-STARTER	96
DCREG2/DCREG4	100
CU400 - Clamping unit for DCREG	106
MJ-MA - ELECTRICAL MOTORS	108
REMOTE DRIVE	110
INDUSTRIAL SECTORS AND APPLICATIONS	112
Santerno worldwide	126

SINUS B



V/f Drive for three-phase asynchronous motors ranging from 0.1 kW to 2.2 kW

- Two product lines: SINUS B and SINUS B PLUS
- The SINUS B has the same look as the SINUS H series, featuring the same design quality, reliability and user-friendliness
- Compatible with the REMOTE DRIVE software allowing remote control (SINUS B PLUS models only)



TOP EFFICIENCY DRIVE
CDM IE2 according to
IEC 61800-9-2

TECHNICAL SPECIFICATIONS AND STRONG POINTS

- Power range: 0.1 ~ 2.2 kW
- Degree of protection: IP20
- Built-in potentiometer
- 2 types of control: V/f and Slip Compensation
- Maximum output power: 400 Hz
- Single-phase power supply: 200 ~ 240 Vac (three-phase output)
- Built-in EMC filter as a standard (Class C2)
- Slim, compact design
- Wireless internal structure based on a board-to-board connector for maximum connection safety
- Can be mounted on a DIN rail
- Allows Zero Stack installation
- Streamlines connection of peripheral devices (Smart Copier and remote keypad) via RS485 port on RJ45 connector
- Global compliance: CE, UL (UL 61800-5-1)
- Built-in braking module (≥1.5 kW)
- RS485 communications (SINUS B PLUS models only)
- Overload capacity: 150% for 1 min.
- Start/stop buttons
- Clockwise and counter-clockwise rotation lock
- DC braking
- JOG function
- Up-down
- 3-wire operation
- Stop function
- Slip compensation
- PID function
- Automatic energy saving
- Prohibit frequencies
- Frequency limits
- N. 3 programmable digital inputs (up to 5 in SINUS B PLUS models)
- N. 1 0-10 Vdc analog input
- N. 1 configurable analog input, 0-10 Vdc or 4-20 mA (SINUS B PLUS models only)
- N. 1 multifunction open-collector output
- N. 1 multifunction relay output (up to 2 multifunction relay outputs in SINUS B PLUS models)
- N. 1 multifunction analog input, 0-10 Vdc
- Speed Search function
- Auto-restart
- BUILT-IN EMC INPUT filters, EN 61800-3, 2nd Edition, FIRST ENVIRONMENT, Category C2, EN55011 gr. 1 cl. A for industrial and domestic networks

OPTIONALS

- Output ferrite filters
- V/I Analog converter (0-10/4-20 mA)
- Relay for open-collector output
- "REMOTE DRIVE" software (SINUS B PLUS models only)
- MODBUS/Profibus DP-CanBus-Device Net etc. converter (SINUS B PLUS models only)
- USB/RS485 converter (SINUS B PLUS models only)

PRODUCT SELECTION CHART

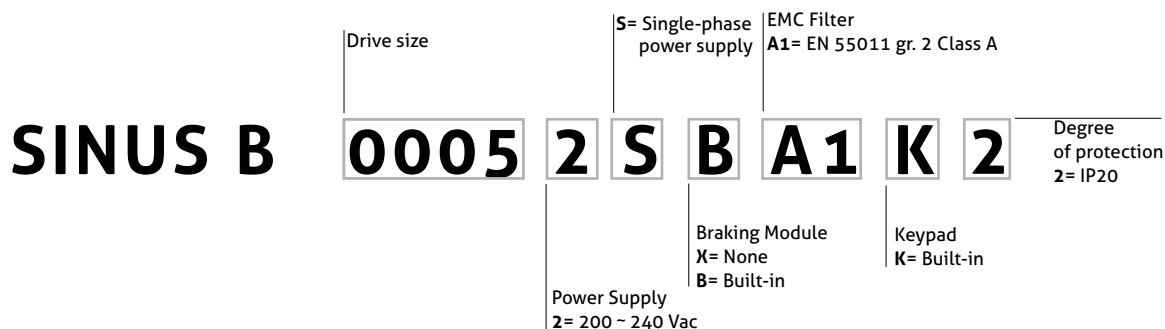

Model	Motor power Heavy Duty		Output Inom	Output Imax 150% (60s)	Dimensions WxHxD	Weight
	kW	HP	A	A	mm	kg
SINUS B 000A 2S XA1K2 SINUS B PLUS 000A 2S XA1K2	0.1	0.125	0.8	1.2	85x135x100	0.65
SINUS B 000B 2S XA1K2 SINUS B PLUS 000B 2S XA1K2	0.2	0.25	1.4	2.1	85x135x100	0.65
SINUS B 0001 2S XA1K2 SINUS B PLUS 0001 2S XA1K2	0.4	0.5	2.4	3.6	85x153x123	0.98
SINUS B 0002 2S XA1K2 SINUS B PLUS 0002 2S XA1K2	0.75	1.0	4.2	6.3	85x153x123	0.98
SINUS B 0003 2S BA1K2 SINUS B PLUS 0003 2S BA1K2	1.5	2.0	7.5	11.25	100x180x140	1.35
SINUS B 0005 2S BA1K2 SINUS B PLUS 0005 2S BA1K2	2.2	3.0	10.0	15.0	100x180x140	1.35

SINUS J



Multi-function AC Motor Drive

- Motor Control Modes: V/f and Vector Sensorless for Asynchronous Motors
- Sinus J 2S/T (220-240 V 1ph): 0.2 ~ 15 kW
- Sinus J 2S/T (200-240 V 3ph): 0.4 ~ 22 kW
- Sinus J 4T (380-480 V 3ph): 0.4 ~ 30 kW
- Overload: up to 150% for 60 seconds (Heavy Duty), up to 120% for 60 seconds (Normal Duty)
- Degree of Protection: IP20



TOP EFFICIENCY DRIVE
CDM IE2 according to
IEC 61800-9-2



TECHNICAL ADVANTAGES AND SPECIFICATIONS

- Control Algorithms: V/f and Vector Sensorless for Asynchronous Motors
- Built-in Dynamic Braking Unit
- Built-in EMC Filter according to EN 61800-3, SECOND ENVIRONMENT Category C3 for industrial locations, available for SINUS J 4T (Group 2, Class A according to EN 55011)
- Selectable Motor Autotuning, while rotating or stopped (allows detecting the motor parameters and getting optimum performance without having the motor rotating)
- Estimation of the remaining running time of the cooling fans: a warning pops up when the expected lifetime of the fans is exceeded
- Easy replacement of the cooling fans: can be replaced from top without removing other drive components
- DIN-rail Mount: up to 4 kW model
- Side-by-side Mount: allows saving space when multiple drives are installed within a cabinet
- Built-in RS-485 Serial Port with Modbus RTU Protocol
- Temperature Range: -10 °C-40 °C (ND) / -10 °C-50 °C (HD)
- Maximum Torque: 200%
- Built-in Potentiometer for Frequency Reference
- Smart Copier for Parameter Duplication
- Approval: UL 61800-5-1/CSA (file number UL E195081)

OPTIONS

- Remotable Keypad
- Keypad Remoting Kit (3- or 5-meter length)
- Conduit Kit NEMA1
- EMC Filter according to EN 61800-3, FIRST ENVIRONMENT Category C1 for domestic locations (Group 1, Class B according to EN 55011)
- Fieldbus Option Boards: Profibus DP; CANopen; Modbus TCP; Ethernet/IP
- Remote Drive Software
- RS-485/USB Converter

PRODUCT SELECTION CHART

SINUS J

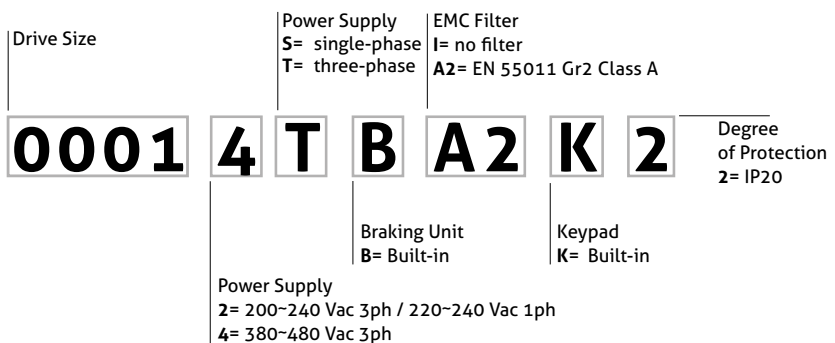

SINUS J



SINUS J 2S/T BIK2

Single phase power supply 220÷240 Vac +10% -5% 50/60 Hz

No built-in EMC Filter

Model	Normal Duty				Heavy Duty				Dimensions WxHxD	Weight
	Pnom	Pnom	Inom	I _{max} (120%)	Pnom	Pnom	Inom	I _{max} (150%)		
	kW	HP	A	A	kW	HP	A	A	mm	kg
2S/T BIK2 - IP20										
SINUS J 0001 2S/T BIK2	0.4	0.5	2	2.4	0.2	0.25	1.5	2.3	154x87x132	1.04
SINUS J 0002 2S/T BIK2	0.75	1.0	3.6	4.3	0.4	0.5	2.8	4.2	154x87x132	1.06
SINUS J 0003 2S/T BIK2	1.1	1.5	5.9	7.1	0.75	1.0	4.6	6.9	167x101x151	1.40
SINUS J 0005 2S/T BIK2	2.2	3.0	6.7	8	1.1	1.5	6.1	9.2	167x101x151	1.42
SINUS J 0007 2S/T BIK2	3	4.0	9.8	11.8	2.2	3.0	9.3	14.0	183x135x151	1.92
SINUS J 0011 2S/T BIK2	4	5.0	16.3	19.6	3	4.0	12.8	19.2	220x180x144	3.08
SINUS J 0014 2S/T BIK2	5.5	7.5	22	26.4	4	5.0	17.4	26.1	220x180x144	3.21
SINUS J 0017 2S/T BIK2	9.2	12.5	31	37.2	5.5	7.5	26.8	40.2	290x180x173	4.89
SINUS J 0020 2S/T BIK2	11	15	38	45.6	9.2	12.5	34	51.0	345x220x173	7.60
SINUS J 0025 2S/T BIK2	15	20	45	54	11	15.0	41	61.5	400x260x187	11.1
SINUS J 0030 2S/T BIK2	-	-	-	-	15	20.0	48	72.0	400x260x187	11.2

SINUS J 2S/T BIK2

Three phase power supply 200÷240 Vac +10% -15% 50/60 Hz

No built-in EMC Filter

Model	Normal Duty				Heavy Duty				Dimensions WxHxD	Weight
	Pnom	Pnom	Inom	I _{max} (120%)	Pnom	Pnom	Inom	I _{max} (150%)		
	kW	HP	A	A	kW	HP	A	A	mm	kg
2S/T BIK2 - IP20										
SINUS J 0001 2S/T BIK2	0.75	1.0	3.1	3.7	0.4	0.5	2.5	3.75	154x87x132	1.04
SINUS J 0002 2S/T BIK2	1.5	2.0	6.0	7.2	0.75	1.0	5.0	7.5	154x87x132	1.06
SINUS J 0003 2S/T BIK2	2.2	3.0	9.6	11.5	1.5	2.0	8.0	12.0	167x101x151	1.40
SINUS J 0005 2S/T BIK2	4.0	5.0	12	14.4	2.2	3.0	11.0	16.5	167x101x151	1.42
SINUS J 0007 2S/T BIK2	5.5	7.5	18	21.6	4.0	5.0	17.0	25.5	183x135x151	1.92
SINUS J 0011 2S/T BIK2	7.5	10	30	36	5.5	7.5	24	36.0	220x180x144	3.08
SINUS J 0014 2S/T BIK2	11	15	40	48	7.15	10.0	32	48.0	220x180x144	3.21
SINUS J 0017 2S/T BIK2	15	20	56	67.2	11	15.0	47	70.5	290x180x173	4.89
SINUS J 0020 2S/T BIK2	18.5	25	70	84	15	20.0	60	90.0	345x220x173	7.60
SINUS J 0025 2S/T BIK2	22	30	82	98.4	18.5	25.0	75	112.5	400x260x187	11.1
SINUS J 0030 2S/T BIK2	-	-	-	-	22	30.0	88	132.0	400x260x187	11.2

SINUS J 4T BA2K2

Three phase power supply 380÷480 Vac +10% -15% 50/60 Hz

EMC compliant EN 61800-3 (Category C3), EN 55011 (Group 2, Class A)

Model	Normal Duty				Heavy Duty				Dimensions WxHxD	Weight
	Pnom	Pnom	Inom	I _{max} (120%)	Pnom	Pnom	Inom	I _{max} (150%)		
	kW	HP	A	A	kW	HP	A	A	mm	kg
4T BA2K2 - IP20										
SINUS J 0001 4T BA2K2	0.75	1.0	2	2.4	0.4	0.5	1.3	2.0	154x87x132	1.04
SINUS J 0002 4T BA2K2	1.5	2.0	3.1	3.7	0.75	1.0	2.5	3.8	154x87x132	1.08
SINUS J 0003 4T BA2K2	2.2	3.0	5.1	6.1	1.5	2.0	4	6.0	167x101x151	1.44
SINUS J 0005 4T BA2K2	4.0	5.0	6.9	8.3	2.2	3.0	5.5	8.3	167x101x151	1.46
SINUS J 0007 4T BA2K2	5.5	7.5	10	12.0	4.0	5.0	9	13.5	183x135x151	1.98
SINUS J 0011 4T BA2K2	7.5	10	16	19.2	5.5	7.5	12	18.0	220x180x144	3.24
SINUS J 0014 4T BA2K2	11	15	23	27.6	7.5	10.0	16	24.0	220x180x144	3.28
SINUS J 0017 4T BA2K2	15	20	31	37.2	11	15.0	24	36.0	290x180x173	5.04
SINUS J 0020 4T BA2K2	18.5	25	38	45.6	15	20.0	31	46.5	290x180x173	5.05
SINUS J 0025 4T BA2K2	22	30	45	54.0	18.5	25.0	39	58.5	345x220x173	7.96
SINUS J 0030 4T BA2K2	30	40	61	73.2	22	30.0	45	67.5	345x220x173	7.98

SINUS H



Multi-purpose Very High Performance AC Drive

- Motor Control: V/f and Vector Sensorless Control
- SINUS H 2S (200-240 V 1ph): 0.4 ~ 2.2 kW
- SINUS H 2T (200-240 V 3ph): 0.4 ~ 15 kW
- SINUS H 4T (380-480 V 3ph): 0.4 ~ 30 kW (*)
- Upload: up to 150% for 60 seconds (Heavy Duty), up to 120% for 60 seconds (Normal Duty)
- Degree of Protection: IP20 and IP66 Variants

(*) Up to 22 kW for IP66



TOP EFFICIENCY DRIVE
CDM IE2 according to
IEC 61800-9-2

TECHNICAL SPECIFICATIONS AND STRONG POINTS

- Control Algorithms: V/f, Vector Sensorless for Asynchronous Motors, Vector Sensorless for Synchronous Motors
- Dynamic braking module built-in up to model SINUS H 0030
- Built-in EMC filter in compliance with EN 61800-3, SECOND ENVIRONMENT, Category C3 for industrial users, available for SINUS H 0.4 ~ 22 kW, three-phase, Class 400 Vac. EMC filter, Category C2, available for SINUS H 0.4 ~ 2.2 kW, single-phase, Class 200 Vac.
- DC inductors integrated into SINUS H 0034. External terminals available for models SINUS H 0001-0030
- Selectable motor autotune: rotating/static; with the static type, autotune detects motor parameters and optimizes the motor's performance without making it rotating
- Lifetime estimation:
 1. Electrolytic capacitors: lifetime estimated by monitoring variations of capacitive values
 2. Fans: a warning pops up when the expected lifetime is exceeded
- Integrated Safety Function: Safe Torque Off - EN 61508 SIL 2 and EN ISO 13849-1 PL 'd'
- Integrated P2P function: The I/Os may be shared between master and slave
- Sequencer function: Simple PLC sequences may be obtained by combining different functional blocks
- Easily replaceable cooling fans: Cooling fans may be replaced with no need to fully disassemble the affected drive
- Side-by-side installation: Multiple drives within a cabinet may be installed side-by-side for a more compact solution
- IP20 Degree of Protection standard supplied. IP66 models up to 22 kW available

OPTIONALS

- LCD graphic keypad
- Keypad remoting kit (3-meter distance)
- EMC Filters EN 55011 CL B, public grid, FIRST ENVIRONMENT
- Braking resistors
- Relay for open-collector output
- NEMA1 kit
- Through-panel mounting kit
- Remote Drive Software
- Option boards: Profibus DP; CANopen; Modbus TCP/IP, Ethernet/IP; I/O Extension; EtherCAT; ProfiNET
- RS485/USB Converter

PRODUCT SELECTION CHART

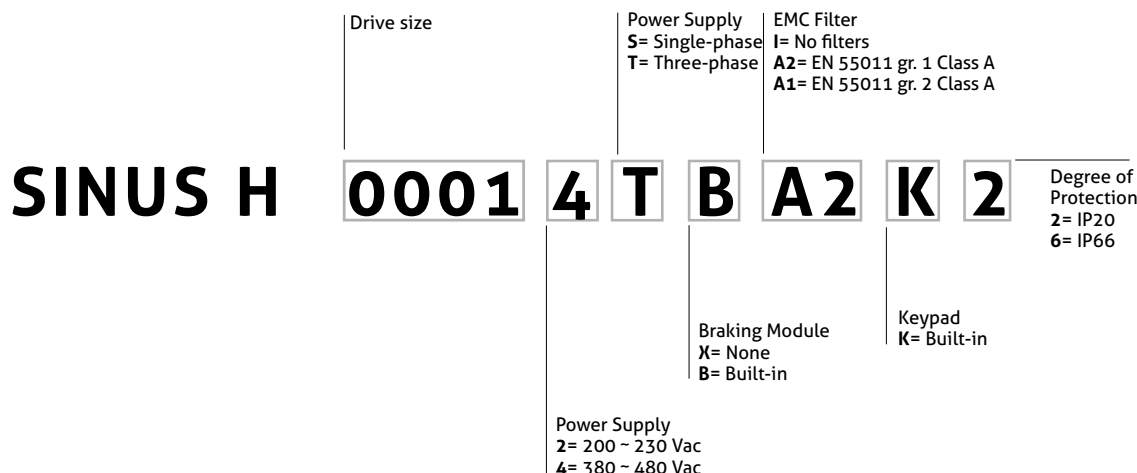

SINUS H



Model	Normal Duty				Heavy Duty				Dimensions WxHxD	Weight
	Pnom	Pnom	Inom	I _{max} (120%)	Pnom	Pnom	Inom	I _{max} (150%)		
	kW	HP	A	A	kW	HP	A	A	mm	kg
2S BA1K2 - IP20										
SINUS H 0001 2S BA1K2	0.75	1.0	3.10	3.7	0.4	0.5	2.5	3.75	68x180x130	1.14
SINUS H 0002 2S BA1K2	1.5	2.0	6.0	7.2	0.75	1.0	5.0	7.5	100x180x140	1.76
SINUS H 0003 2S BA1K2	2.2	3.0	9.6	11.5	1.5	2.0	8.0	12.0	100x180x140	1.76
SINUS H 0005 2S BA1K2	3.7	5.0	12.0	14.4	2.2	3.0	11.0	16.5	140x180x140	2.22
2T BIK2 - IP20										
SINUS H 0001 2T BIK2	0.75	1.0	3.1	3.7	0.4	0.5	2.5	3.75	68x128x123	0.9
SINUS H 0002 2T BIK2	1.5	2.0	6.0	7.2	0.75	1.0	5.0	7.5	68x128x128	0.9
SINUS H 0003 2T BIK2	2.2	3.0	9.6	11.5	1.5	2.0	8.0	12.0	100x128x130	1.3
SINUS H 0005 2T BIK2	3.7	5.0	12.0	14.4	2.2	3.0	11.0	16.5	100x128x145	1.5
SINUS H 0007 2T BIK2	5.5	7.5	18.0	21.6	4.0	5.4	17.0	25.5	140x128x145	2.0
SINUS H 0011 2T BIK2	7.5	10.0	30.0	36.0	5.5	7.5	24.0	36.0	160x232x140	3.3
SINUS H 0014 2T BIK2	11.0	15.0	40.0	48.0	7.5	10.0	32.0	48.0	160x232x140	3.3
SINUS H 0017 2T BIK2	15.0	20.0	56.0	67.2	11.0	15.0	46.0	69.0	180x290x163	4.6
SINUS H 0020 2T BIK2	18.5	25.0	69.0	82.8	15.0	20.0	60.0	90.0	220x350x187	7.1
4T BA2K2 / XA2K2 - IP20										
SINUS H 0001 4T BA2K2	0.75	1.0	2.0	2.4	0.4	0.5	1.3	1.95	68x180x130	1.18
SINUS H 0002 4T BA2K2	1.5	2.0	3.1	3.7	0.75	1.0	2.5	3.75	68x180x130	1.18
SINUS H 0003 4T BA2K2	2.2	3.0	5.1	6.1	1.5	2.0	4.0	6.0	100x180x140	1.77
SINUS H 0005 4T BA2K2	3.7	5.0	6.9	8.3	2.2	3.0	5.5	8.25	100x180x140	1.80
SINUS H 0007 4T BA2K2	5.5	7.5	10.0	12.0	4.0	5.4	9.0	13.5	140x180x140	2.23
SINUS H 0011 4T BA2K2	7.5	10.0	16.0	19.2	5.5	7.5	12.0	18.0	160x232x140	3.3
SINUS H 0014 4T BA2K2	11.0	15.0	23.0	27.6	7.5	10.0	16.0	24.0	160x232x140	3.4
SINUS H 0017 4T BA2K2	15.0	20.0	30.0	36.0	11.0	15.0	24.0	36.0	180x290x163	4.6
SINUS H 0020 4T BA2K2	18.5	25.0	38.0	45.6	15.0	20.0	30.0	45.0	180x290x163	4.8
SINUS H 0025 4T BA2K2	22.0	30.0	44.0	52.8	18.5	25.0	39.0	58.5	220x350x187	7.5
SINUS H 0030 4T BA2K2	30.0	40.0	58.0	69.6	22.0	30.0	45.0	67.5	220x350x187	7.5
SINUS H 0034 4T BA2K2	37.0	50.0	75.0	90.0	30.0	40.0	61.0	91.5	275x450x284	11.8



Model	Normal Duty				Heavy Duty				Dimensions WxHxD	Weight
	Pnom	Pnom	Inom	I _{max} (120%)	Pnom	Pnom	Inom	I _{max} (150%)		
	kW	HP	A	A	kW	HP	A	A	mm	kg
2T BIK6 - IP66										
SINUS H 0001 2T BIK6	-	-	-	-	0.4	0.5	2.5	3.75	180x257x174	3.6
SINUS H 0002 2T BIK6	-	-	-	-	0.75	1.0	5.0	7.5	180x257x174	3.6
SINUS H 0003 2T BIK6	-	-	-	-	1.5	2.0	8.0	12.0	220x259x201	5.2
SINUS H 0005 2T BIK6	-	-	-	-	2.2	3.0	11.0	16.5	220x259x201	5.3
SINUS H 0007 2T BIK6	-	-	-	-	4.0	5.4	17.0	25.5	220x259x201	5.6
SINUS H 0011 2T BIK6	-	-	-	-	5.5	7.5	24.0	36.0	250x328x227	9.0
SINUS H 0014 2T BIK6	-	-	-	-	7.5	10.0	32.0	48.0	250x328x227	9.0
SINUS H 0017 2T BIK6	-	-	-	-	11.0	15.0	46.0	69.0	260x400x245	9.6
SINUS H 0020 2T BIK6	-	-	-	-	15.0	20.0	60.0	90.0	300x460x250	12.1
4T BA2K6 - IP66										
SINUS H 0001 4T BA2K6	-	-	-	-	0.4	0.5	1.3	2.0	180x257x174	3.7
SINUS H 0002 4T BA2K6	-	-	-	-	0.75	1.0	2.5	3.75	180x257x174	3.7
SINUS H 0003 4T BA2K6	-	-	-	-	1.5	2.0	4.0	6.0	220x259x201	5.3
SINUS H 0005 4T BA2K6	-	-	-	-	2.2	3.0	5.5	8.25	220x259x201	5.5
SINUS H 0007 4T BA2K6	-	-	-	-	4.0	5.4	9.0	13.5	220x259x201	5.6
SINUS H 0011 4T BA2K6	-	-	-	-	5.5	7.5	12.0	18.0	250x328x227	8.8
SINUS H 0014 4T BA2K6	-	-	-	-	7.5	10.0	16.0	24.0	250x328x227	8.9
SINUS H 0017 4T BA2K6	-	-	-	-	11.0	15.0	24.0	36.0	260x400x245	9.6
SINUS H 0020 4T BA2K6	-	-	-	-	15.0	20.0	30.0	45.0	260x400x245	9.8
SINUS H 0025 4T BA2K6	-	-	-	-	18.5	25.0	39.0	58.5	300x460x250	12.4
SINUS H 0001 4T BA2K6	-	-	-	-	22.0	30.0	45.0	67.5	300x460x250	12.4

SINUS S



Modular, compact and flexible drive

SINUS S 4T: 380 ÷ 480 Vac, 0.37 ÷ 37 kW

- Motor Control Methods
 - V/f open loop (VFC)
 - V/f closed loop (VFC closed loop)
 - Sensorless Vector Control (SLVC),
 - Servo Control closed loop (SC-ASM)
 - Sensorless Permanent Magnet Motor Control (SLPMSM)
- Overload HEAVY DUTY 200% per 3 s, 150% per 60 s
- Overload LIGHT DUTY 120% per 60 s
- Protection degree: IP20 version



TOP EFFICIENCY DRIVE
CDM IE2 according to
IEC 61800-9-2

MAIN FEATURES AND HIGHLIGHTS

- I/O Flexibility (Standard I/O & Application I/O); PNP/NPN configurable inputs
- Standard I/O Control Unit with built-in field bus: CANopen, Modbus RTU, Profibus, EtherCAT, Profinet, Ethernet-IP, Modbus TCP
- Removable terminal blocks for easy connections
- Internal or external +24 Vdc
- Side by Side Installation (zero clearance mounting)
- Accessible DC BUS for ENERGY SHARING applications
- PTC input for motor thermal protection
- SEQUENCER up to 8 PLC programmable sequences of 16 steps each
- Built-in EMC filter for TT, TN, IT networks: C1, C2 or C3 Category (EN61800-3), depending on models and motor cable length
- EMC screen on control board

ADVANCED FUNCTIONS

- "Favorite" parameters menu on the Display/Keypad
- Energy Saving function (VFeco)
- Integrated ANTI-SWAY algorithm to reduce the oscillation of gravitational loads during horizontal movements
- Advanced diagnostics menu (history buffer of the last 32 error and warning messages of the inverter)
- High torque also at low frequencies: 200% / 0.5 Hz
- Tuning of the motor: standstill or running
- Tuning of the speed controller

OPTIONS

- | | |
|--|---|
| <ul style="list-style-type: none"> - LCD display/keypad with EASY NAVIGATION functionality - Safe function: Safe Torque Off Cat. 4 / PL "e" (EN ISO 13489-1) SIL 3 / SIL CL 3 (IEC 61800-5-2 / IEC 61508 / IEC 62061) - EMC filters for long and short distances. | <ul style="list-style-type: none"> - Braking resistors - Mains chokes - Output sinusoidal filters - EMC shield for power cables connections - Software "REMOTE SINUS" module via USB or WLAN |
|--|---|

SINUS S



Model POWER UNITS	Heavy Duty					Light Duty					Dimensions WxHxD mm	Weight kg
	Rated power @ 45 °C kW	400 Vac		480 Vac		Rated power @ 40 °C kW	400Vac		480 Vac			
		Rated output current A	Overload current (60 s) A	Rated output current A	Overload current (60 s) A		Rated output current A	Overload current (60 s) A	Rated output current A	Overload current (60 s) A		
SINUS S 0001 4T BA2K2	0.37	1.3	2	1.1	1.7	0.37	1.3	2	1.1	1.7	155 x 60 x 130	0.8
SINUS S 0002 4T BA2K2	0.75	2.4	3.6	2.1	3.2	0.75	2.4	3.6	2.1	3.2	180 x 60 x 130	1
SINUS S 0003 4T BA2K2	1.5	3.9	5.9	3.5	5.3	1.5	3.9	5.9	3.5	5.3	250 x 60 x 130	1.35
SINUS S 0005 4T BA2K2	2.2	5.6	8.4	4.8	7.2	2.2	5.6	8.4	4.8	7.2	250 x 60 x 130	1.35
SINUS S 0006 4T BA2K2	3	7.3	11	6.3	9.5	4	8.8	11	7.6	9.5	250 x 60 x 130	1.35
SINUS S 0007 4T BA2K2	4	9.5	14.3	8.2	12.3	5.5	11.9	14.3	9.8	12.3	250 x 60 x 130	1.35
SINUS S 0011 4T BA2K2	5.5	13	19.5	11	16.5	7.5	15.6	19.5	13.2	16.5	250 x 90 x 130	2.3
SINUS S 0014 4T BA2K2	7.5	16.5	25	14	21	11	23	23.6	18.3	21	276 x 120 x 130	3.7
SINUS S 0017 4T BA2K2	11	23.5	35	21	31.5	15[*]	28.2	35	25.2	31.5	276 x 120 x 130	3.7
SINUS S 0020 4T BA2K2	15	32	48	27	40.5	18.5	38.4	48	32.4	40.5	347 x 204.5 x 222	10.3
SINUS S 0025 4T BA2K2	18.5	40	60	34	51	22[*]	48	60	40.8	51	347 x 204.5 x 222	10.3
SINUS S 0030 4T BA2K2	22[*]	47	71	40.4	61	30[*]	56.4	71	48.5	61	347 x 204.5 x 222	10.3
SINUS S 0034 4T BA2K2	30[*]	61	92	52	78	37[*]	73.2	92	62.4	78	450 x 250 x 230	17.2

[*] MAINS CHOKE REQUIRED

CONTROL UNITS

SINUS S CTRL UNIT w/Standard-I/O
SINUS S CTRL UNIT w/Application-I/O
SINUS S CTRL UNIT w/CANopen
SINUS S CTRL UNIT w/Modbus RTU
SINUS S CTRL UNIT w/Modbus TCP
SINUS S CTRL UNIT w/PROFIBUS
SINUS S CTRL UNIT w/EtherCAT
SINUS S CTRL UNIT w/PROFINET
SINUS S CTRL UNIT w/EtherNetIP

OPZIONI

SINUS S Blanking cover
SINUS S Display and keyboard
SINUS S USB comm. module
SINUS S Wi-Fi comm. module
SINUS S Ext Keypad KIT w/3m-cable (senza SINUS S Display and keyboard)
SINUS S Safety function STO

View from above

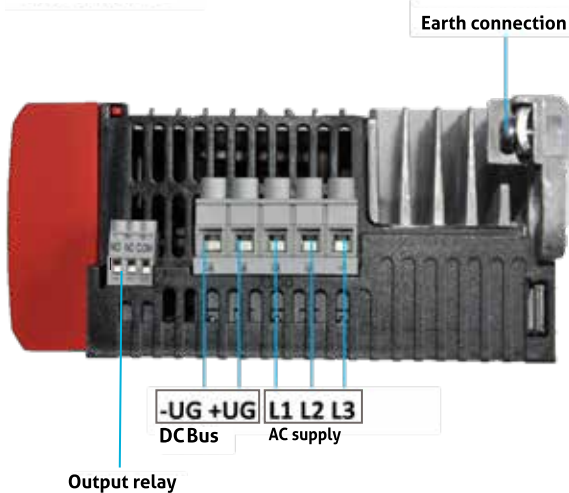

View from below

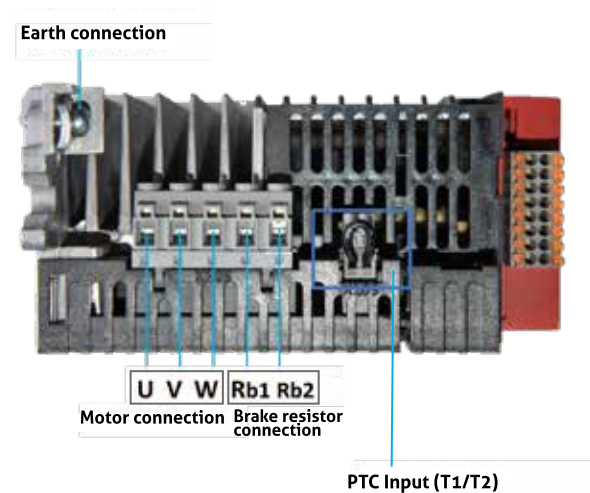

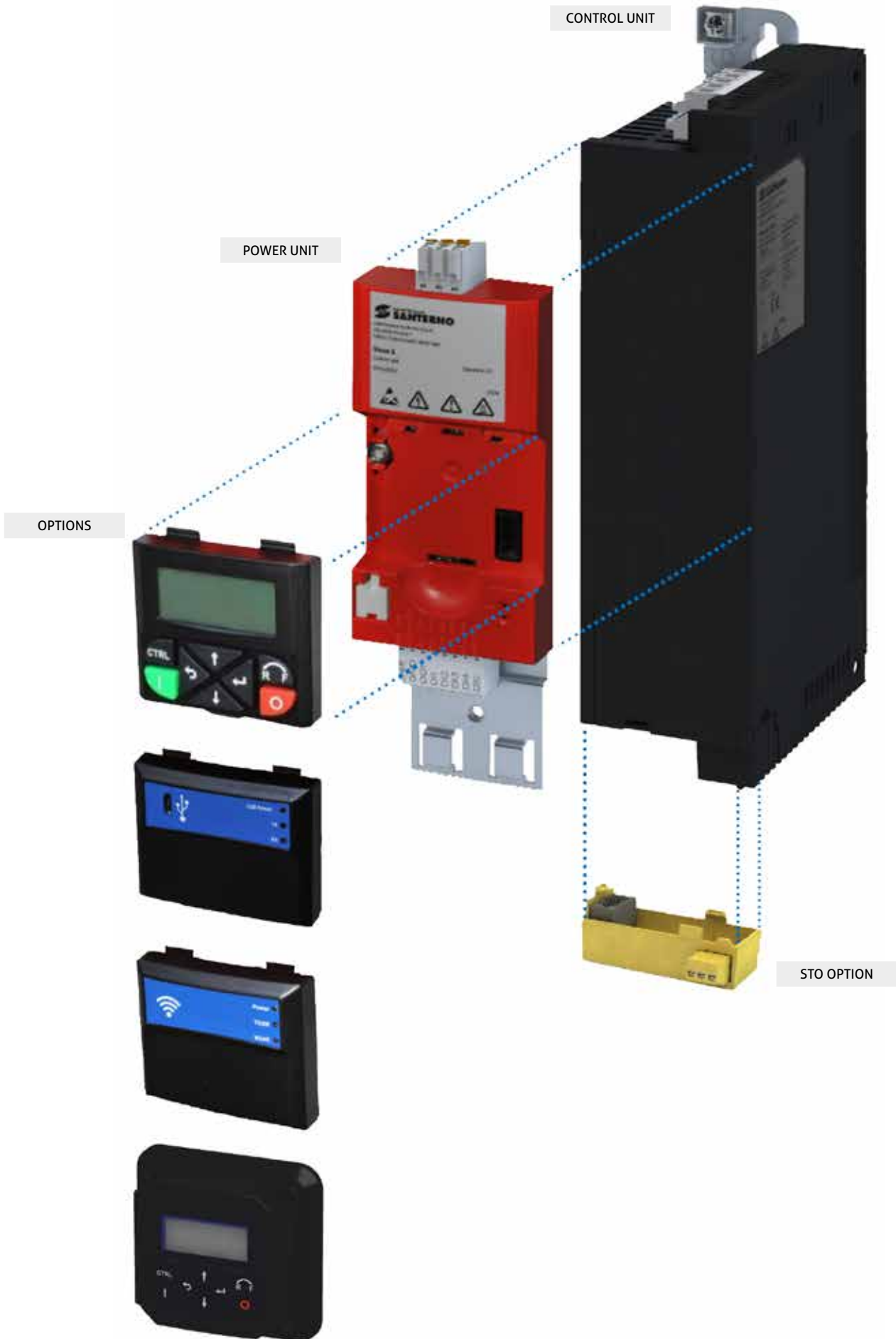

SINUS PENTA

Premium Drives for all applications

Full range of premium drives for AC three-phase induction and synchronous motors

5 different control functions: V/F, Sensorless VTC, FOC, SYN, regenerative.

Available in IP00, IP20, IP54 enclosures.

Complete range of inductors, filters, braking unit and resistors.

Complete range of optional boards: speed sensors, communications, I/O expansion, field bus, dataloggers.



Marine applications
special-purpose
product line available
(page n. 48)



TOP EFFICIENCY DRIVE
CDM IE2 according to
IEC 61800-9-2

SINUS PENTA



SINUS PENTA



The SINUS PENTA drives have one common part number coding. Refer to this coding to select the specific model and options required for your application. The part number starts with "SINUS P" that identifies the SINUS PENTA family, the following 4 digit number identifies the inverter model. The part number details are given below

PRODUCT SELECTION CHART

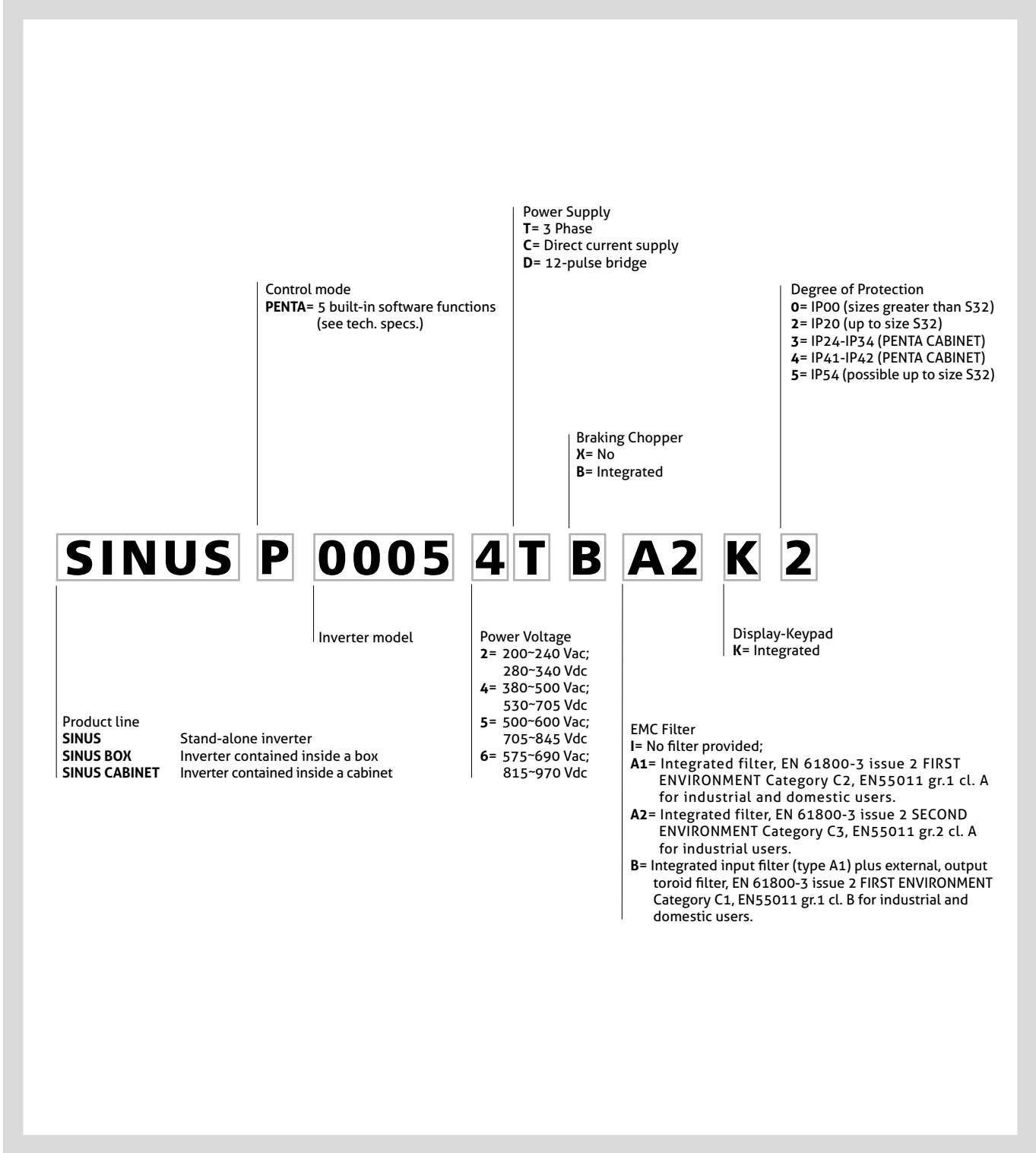

NOTE: Not all combinations are possible

OVERLOAD CHOICE

Applications	Overload			
	Light	Standard	Heavy	Strong
Agitator		•		
Atomizer	•			
Axis control			•	•
Ball mill			•	
Bandsaw	•			
Bore pumps			•	
Bottle washer	•			
Calenders		•	•	
Centrifugal damped fan	•			
Centrifugal pumps		•		
Centrifuge		•		
Chipper		•		
Circular saw		•		
Conveyor belt		•	•	
Conveyor roller		•		
Conveyor screw			•	
Crusher cone		•		
Crusher jaw			•	
Crusher rotary		•		
Crusher vertical impact		•		
Damped axial fan	•			
Debarker		•		
Drawplates		•	•	
Drills			•	•
Dryer		•	•	
Dust collector	•			
Hedger		•		
Elevators			•	•
Extruders	•			
Forming machines		•	•	
Grinder	•			
Hammer mill		•		
High pressure fan	•			

Applications	Overload			
	Light	Standard	Heavy	Strong
Hoists and cranes' translation			•	
Hydraulic power pack		•		
Hydraulic power pack injection moulding machines		•		
Industrial washers			•	
Loaded piston compressor			•	
Looms		•	•	
Mechanical presses		•	•	
Mill		•		
Mixer	•			
Palletiser		•	•	
Planers		•		
Positive displacement pumps			•	
Pulper		•		
Roller mill		•		
Rolling plants			•	
Rotary table		•		
Sander		•	•	
Screw compressor, loaded		•		
Screw compressor, unloaded	•			
Screw injection moulding machines		•	•	
Separator	•			
Shears		•	•	
Shredder	•			
Slicer	•			
Slurry pumps		•		
Thumbler	•			
Twister/spinner			•	•
Undamped axial fan	•			
Undamped centrifugal fan	•			
Unloaded piston compressor		•		
Vibrating screen	•			
Winding/Unwinding		•	•	

SINUS PENTA 2T/4T



Drives 1.3 kW to 2100 kW for:

- ***Three-phase asynchronous motor control***
- ***Three-phase synchronous motor control***
- ***Regeneration into the grid***

- Wide power supply voltage range, 200÷500 Vac
- DC power supply range 280÷705 Vdc
- Input frequency 50 - 60 Hz
- Available in cabinet up to 2100 kW
- Enclosure IP00, IP20, IP54
- Full compatibility with the "REMOTE DRIVE" software for remote control

SUPPLY VOLTAGE
2T = 200-240 VAC
4T = 380-500 VAC

**3 YEARS
WARRANTY**

TECHNICAL HIGHLIGHTS

One product, 5 integrated functions

- **IFD** (Inverter Frequency Drive): vector modulation function for general-purpose applications (V/F pattern).
- **VTC** (Vector Torque Control): fsensorless vector function for high-torque demanding applications.
- **FOC** (Field Oriented Control): vector function with encoder for high torque precision and wide speed range.
- **SYN** (Synchronous): vector function for brushless synchronous motors with permanent magnets, high torque precision joined to high energy efficiency level.
- **RGN** (Regenerative): sinusoidal power factor $\cos \varphi = 1$, AC/DC feeder function for direct supply of a series of drives.
- Extremely compact dimensions: one of the best current density [A/m³] in the market.
- Widest range of STANDARD I/O.
- Most encoder input directly to control board, no option board required for FOC control.
- Open loop speed precision: $\pm 0.5\%$ of max. speed. Closed loop (with an encoder) speed precision: $< 0.01\%$ of max. speed.
- Intelligent cooling system. Through-Hole mounting, segregation of forced air flow channels.
- Integrated braking chopper up to S30 at 100% nominal current.
- Programmable logic blocks.
- Regulation of output frequency from 0 to 1000 Hz (depending on models).
- Lower motor noise with random modulation and carrier frequency up to 16 kHz (depending on models).
- Integrated EMC filters on the full range in compliance with EN61800-3 2nd ed.
- INTEGRATED INPUT FILTERS, EMC EN61800-3, 2nd edition, SECOND ENVIRONMENT Category C3, EN55011 gr.2 cl. A, for residential and industrial environments
- STO (Safe Torque Off) Function in compliance with EN 61800-5-2 SIL 3, EN ISO 13849 PL d.
- Designed according to IEC guidelines 60721-3-3, category 3C2

TECHNICAL FEATURES

SINUS PENTA inverters fit any application thanks to their advanced features, among which: vector modulation; power control with the latest IGBTs; high immunity to radio interference; high overload capability.

- Easy commissioning with preset parameters for the most common applications.
- Operating parameters saved to removable keypad or PC and possibility of parameter transfer to multiple inverters.
- Control panel with 12 keys and large back-lit LCD.
- Automatic calibration for motor parameters tuning.
- Programmable multiple acceleration and deceleration ramps. Programmable S ramps.
- Automatic DC braking.
- Motor PTC thermal probe control. Integrated motor thermal protection.
- In case of power failure, total control of the motor, down to 0 RPM.
- Master-slave function for the operation of several motors connected to the same drive shaft (VTC and FOC).
- 200% max torque.
- PID Function / Second PID Function / 2-zone PID.
- Skip frequency.
- Integrated digital potentiometer. Integrated multifunctional tester.
- Fire Mode function available.
- Trip Log.
- STANDARD I/Os:
 - Encoder feedback
 - 8 programmable inputs and MPL logic
 - 3 programmable analog inputs 0-10 Vdc, 0(4)-20 mA, PTC
 - 4 programmable digital output (2 relays with exchange contact, 1 open-collector, 1 Push-Pull)
 - Auxiliary input frequency 5,000-65,000 Hz, Auxiliary output frequency 5,000-65,000 Hz
 - 3 programmable analog outputs 0-10 Vdc, 0(4)-20 mA.
- Auxiliary output voltage 24 Vdc, 10 Vdc.
- Serial communications RS485 with MODBUS RTU protocol up to 38.400 Baud.

SPECIAL CONFIGURATIONS

- 12 pulse bridge: starting from the S41 size, it is possible to supply the drive on 12-pulse bridge configuration.
- Optional boards for Fieldbus communication, Encoder or Resolver interface, Data loggers, RTC, I/O expansion.
- Custom execution in box or cabinets with input and/or DC and/or output inductors, circuit breakers, AFE sensors and switch.

SINUS PENTA 2T/4T



TECHNICAL DATA

Connected motor power range / voltage range

1.5~260 kW	200÷240 Vac	3phase
2.2~1750 kW	380÷415 Vac	3phase
3.0~2000 kW	440÷460 Vac	3phase
3.7~2100 kW	480÷500 Vac	3phase

Mains Vac supply voltage and frequency

2T	200÷240 Vac, 3phase, -15% +10%	50÷60 Hz
4T	380÷500 Vac, 3phase, -15% +10%	50÷60 Hz

DC supply voltage

2T	280÷340 Vdc
4T	530÷705 Vdc

Overvoltage category

III (refer to EN 61800-5-1)

Degree of protection/size

IP20 from size S05 to size S30,
IP00 from size S41 to size S65,
IP54 from size S05 to size S30

Ambient temperature

- 10°C to 55°C with no derating (or 2%/°C over 40°C, based on the inverter model and the application category)

Storage temperature

-25 ÷ +70°C

Humidity

5 ÷ 95% (non condensing)

Altitude

Standard max. altitude 2000 m a.s.l.
(2000 m ÷ 4000 m, on request)
Above 1000 m, derate 1%/100 m.

Vibrations

Lower than 9.8 m/sec² (= 1.0G)

Operating atmospheric pressure

86 ÷ 106 kPa

Cooling system

Forced air-cooling

Environmental conditions

Designed according to the guidelines
IEC 60721-3-3, category 3C2



DIMENSIONS AND WEIGHT IP20 - IP00 MODELS

Size	W (mm)	H (mm)	D (mm)	Weight (kg)
S05	170	340	175	7
S12	215	401	225	12,5
S15	225	466	331	22,5
S20	279	610	332	36
S30	302	748	421	51
S41	500	882	409	121
S51	578	882	409	141
S60	890	1310	530	260
S65	980	1400	560	440



SINUS PENTA 2T/4T



LIGHT OVERLOAD UP TO 120% (120s) OR UP TO 144% (3s)

Power supply up to 500 Vac

Sinus Penta Model	2T			4T									Inom.	Imax	Ipeak (3s)
	200-240 Vac			380-415 Vac			440-460 Vac			480-500 Vac					
	kW	CV	A	kW	CV	A	kW	CV	A	kW	CV	A			
Size S05															
SINUS PENTA 0005	-	-	-	4.5	6	9	5.5	7.5	9.7	6.5	9	10.2	10.5	11.5	14
SINUS PENTA 0007	3	4	11.2	5.5	7.5	11.2	7.5	10	12.5	7.5	10	11.8	12.5	13.5	16
SINUS PENTA 0008	3.7	5	13.2	-	-	-	-	-	-	-	-	-	15	16	19
SINUS PENTA 0009	-	-	-	7.5	10	14.5	9.2	12.5	16	9.2	12.5	14.3	16.5	17.5	19
SINUS PENTA 0010	4	5.5	14.6	-	-	-	-	-	-	-	-	-	17	19	23
SINUS PENTA 0011	-	-	-	7.5	10	14.8	9.2	12.5	16	11	15	16.5	16.5	21	25
SINUS PENTA 0013	4.5	6	15.7	-	-	-	-	-	-	-	-	-	19	21	25
SINUS PENTA 0014	-	-	-	7.5	10	14.8	9.2	12.5	16	11	15	16.5	16.5	25	30
SINUS PENTA 0015	5.5	7.5	19.5	-	-	-	-	-	-	-	-	-	23	25	30
SINUS PENTA 0016	7.5	10	25.7	-	-	-	-	-	-	-	-	-	27	30	36
SINUS PENTA 0020 ¹⁾	9.2	12.5	30	-	-	-	-	-	-	-	-	-	30	36	43
Size S12															
SINUS PENTA 0016	-	-	-	11	15	21	15	20	25	15	20	23.2	27	30	36
SINUS PENTA 0017	-	-	-	15	20	29	18.5	25	30	18.5	25	28	30	32	37
SINUS PENTA 0020	-	-	-	15	20	29	18.5	25	30	18.5	25	28	30	36	43
SINUS PENTA 0023	11	15	36	-	-	-	-	-	-	-	-	-	38	42	51
SINUS PENTA 0025	-	-	-	22	30	41	22	30	36	22	30	33	41	48	58
SINUS PENTA 0030	-	-	-	22	30	41	22	30	36	25	35	37	41	56	67
SINUS PENTA 0033	15	20	50	-	-	-	-	-	-	-	-	-	51	56	68
SINUS PENTA 0034	-	-	-	30	40	55	30	40	48	37	50	53	57	63	76
SINUS PENTA 0036	-	-	-	30	40	55	37	50	58	37	50	53	60	72	86
SINUS PENTA 0037	18.5	25	61	-	-	-	-	-	-	-	-	-	65	72	83
Size S15															
SINUS PENTA 0040	22	30	71	37	50	67	45	60	70	50	70	70	72	80	88
SINUS PENTA 0049	25	35	80	45	60	80	50	65	75	55	75	78	80	96	115
Size S20															
SINUS PENTA 0060	28	38	88	50	70	87	55	75	85	65	90	88	88	112	134
SINUS PENTA 0067	30	40	96	55	75	98	65	90	100	75	100	103	103	118	142
SINUS PENTA 0074	37	50	117	65	90	114	75	100	116	85	115	120	120	144	173
SINUS PENTA 0086	45	60	135	75	100	133	90	125	135	90	125	127	135	155	186
Size S30															
SINUS PENTA 0113	55	75	170	100	135	180	110	150	166	132	180	180	180	200	240
SINUS PENTA 0129	65	90	195	110	150	191	125	170	192	140	190	195	195	215	258
SINUS PENTA 0150	70	95	213	120	165	212	132	180	198	150	200	211	215	270	324
SINUS PENTA 0162	75	100	231	132	180	228	150	200	230	175	238	240	240	290	324
Inverter power supply	200-240 Vac; 280-340 Vdc			380-500 Vac; 530-705 Vdc											

1) Unavailable model as IP54 - 2) Cabinet version only available on demand - 3) input reactor and output reactor required.

Key Inom= inverter nominal current • Imax= inverter maximum current for 120sec every 20min. up to S30 and 60sec. every 10min. >=S41 • Ipeak= inverter maximum current for 3sec
Note: The indicated motor currents refer to standard 4 pole motors, with IE2 efficiency

LIGHT OVERLOAD UP TO 120% (60s) OR UP TO 144% (3s)
Power supply up to 500 Vac

Sinus Penta Model	2T			4T									Inom.	Imax	Ipeak (3s)	
	200-240 Vac			380-415 Vac			440-460 Vac			480-500 Vac						
	kW	CV	A	kW	CV	A	kW	CV	A	kW	CV	A				A
Size S41																
SINUS PENTA 0180	90	125	277	160	220	273	200	270	297	220	300	300	300	340	408	
SINUS PENTA 0202	110	150	332	200	270	341	220	300	326	250	340	337	345	420	504	
SINUS PENTA 0217	120	165	375	220	300	375	250	340	366	260	350	359	375	460	552	
SINUS PENTA 0260	132	180	390	250	340	421	280	380	410	300	410	418	425	560	672	
Size S51																
SINUS PENTA 0313	160	220	475	280	380	480	315	430	459	355	485	471	480	600	720	
SINUS PENTA 0367	185	250	550	315	430	528	375	510	540	400	550	544	550	680	792	
SINUS PENTA 0402	200	270	593	400	550	680	450	610	665	500	680	673	680	850	1020	
Size S60																
SINUS PENTA 0457	250	340	732	400	550	680	450	610	665	500	680	673	720	880	1056	
SINUS PENTA 0524	260	350	780	450	610	765	500	680	731	560	760	751	800	960	1152	
Size S60P																
SINUS PENTA 0598P	-	-	-	500	680	841	560	760	817	630	860	864	900	1100	1152	
Size S65³⁾																
SINUS PENTA 0598	-	-	-	500	680	841	560	760	817	630	860	864	900	1100	1320	
SINUS PENTA 0748	-	-	-	560	760	939	630	860	939	710	970	960	1000	1300	1560	
SINUS PENTA 0831	-	-	-	710	970	1200	800	1090	1160	900	1230	1184	1200	1440	1728	
Size S75²⁾																
SINUS PENTA 0964	-	-	-	900	1230	1480	1000	1360	1431	1100	1500	1480	1480	1780	2136	
SINUS PENTA 1130	-	-	-	1000	1360	1646	1170	1600	1700	1270	1730	1700	1700	2040	2448	
SINUS PENTA 1296	-	-	-	1200	1650	2050	1400	1830	2000	1460	1990	2050	2100	2520	3024	
Size S90²⁾																
SINUS PENTA 1800	-	-	-	1500	2000	2500	1750	2400	2500	1850	2500	2500	2600	3100	3720	
SINUS PENTA 2076	-	-	-	1750	2400	2900	2000	2720	2900	2100	2900	2900	3000	3600	4000	
Inverter power supply	200-240 Vac; 280-340 Vdc			380-500 Vac; 530-705 Vdc												

SINUS PENTA IN PARALLEL

Sinus Penta Model	2T			4T									Inom.	Imax	Ipeak (3s)	
	200-240 Vac			380-415 Vac			440-460 Vac			480-500 Vac						
	kW	CV	A	kW	CV	A	kW	CV	A	kW	CV	A				A
Size S43 (2xS41)³⁾																
SINUS PENTA 0523	260	350	780	450	610	765	500	680	731	560	760	751	800	960	-	
Size S53 (2xS51)³⁾																
SINUS PENTA 0599	-	-	-	500	680	841	560	760	817	630	860	864	900	1100	-	
SINUS PENTA 0749	-	-	-	560	760	939	630	860	939	710	970	960	1000	1300	-	
SINUS PENTA 0832	-	-	-	710	970	1200	800	1090	1160	900	1230	1184	1200	1440	-	
Size S55 (3xS51)³⁾																
SINUS PENTA 0850	-	-	-	800	1090	1334	900	1230	1287	1000	1360	1317	1340	1600	-	
SINUS PENTA 0965	-	-	-	900	1230	1480	1000	1360	1431	1100	1500	1480	1480	1780	-	
SINUS PENTA 1129	-	-	-	1000	1360	1646	1170	1600	1700	1270	1730	1700	1700	2040	-	
Inverter power supply	200-240 Vac; 280-340 Vdc			380-500 Vac; 530-705 Vdc												

1) Unavailable model as IP54 - 2) Cabinet version only available on demand - 3) input reactor and output reactor required.

Key Inom= inverter nominal current • Imax= inverter maximum current for 120sec every 20min. up to S30 and 60sec. every 10min. >=S41 • Ipeak= inverter maximum current for 3sec
 Note: The indicated motor currents refer to standard 4 pole motors, with IE2 efficiency

SINUS PENTA 2T/4T



STANDARD OVERLOAD UP TO 140% (120s) OR UP TO 168% (3s)

Power supply up to 500 Vac

Sinus Penta Model	2T			4T									Inom.	Imax	Ipeak (3s)	
	200-240 Vac			380-415 Vac			440-460 Vac			480-500 Vac						
	kW	CV	A	kW	CV	A	kW	CV	A	kW	CV	A				A
Size S05																
SINUS PENTA 0005	-	-	-	4	5.5	8.4	4.5	6	7.8	5.5	7.5	9	10.5	11.5	14	
SINUS PENTA 0007	2.2	3	8.5	4.5	6	9	5.5	7.5	9.7	6.5	9	10.2	12.5	13.5	16	
SINUS PENTA 0008	3	4	11.2	-	-	-	-	-	-	-	-	-	15	16	19	
SINUS PENTA 0009	-	-	-	5.5	7.5	11.2	7.5	10	12.5	7.5	10	11.8	16.5	17.5	19	
SINUS PENTA 0010	3.7	5	13.2	-	-	-	-	-	-	-	-	-	17	19	23	
SINUS PENTA 0011	-	-	-	7.5	10	14.8	9.2	12.5	15.6	9.2	12.5	14.3	16.5	21	25	
SINUS PENTA 0013	4	5.5	14.6	-	-	-	-	-	-	-	-	-	19	21	25	
SINUS PENTA 0014	-	-	-	7.5	10	14.8	9.2	12.5	15.6	11	15	16.5	16.5	25	30	
SINUS PENTA 0015	4.5	6	15.7	-	-	-	-	-	-	-	-	-	23	25	30	
SINUS PENTA 0016	5.5	7.5	19.5	-	-	-	-	-	-	-	-	-	27	30	36	
SINUS PENTA 0020 ¹⁾	7.5	10	25.7	-	-	-	-	-	-	-	-	-	30	36	43	
Size S12																
SINUS PENTA 0016	-	-	-	9.2	12.5	17.9	11	15	18.3	15	20	23.2	27	30	36	
SINUS PENTA 0017	-	-	-	11	15	21	11	15	18.3	15	20	23.2	30	32	37	
SINUS PENTA 0020	-	-	-	15	20	29	15	20	25	18.5	25	28	30	36	43	
SINUS PENTA 0023	9.2	12.5	30	-	-	-	-	-	-	-	-	-	38	42	51	
SINUS PENTA 0025	-	-	-	18.5	25	35	18.5	25	30	22	30	33	41	48	58	
SINUS PENTA 0030	-	-	-	22	30	41	22	30	36	25	35	37	41	56	67	
SINUS PENTA 0033	11	15	36	-	-	-	-	-	-	-	-	-	51	56	68	
SINUS PENTA 0034	-	-	-	25	35	46	30	40	48	30	40	44	57	63	76	
SINUS PENTA 0036	-	-	-	30	40	55	30	40	48	37	50	53	60	72	86	
SINUS PENTA 0037	15	20	50	-	-	-	-	-	-	-	-	-	65	72	83	
Size S15																
SINUS PENTA 0040	18.5	25	61	30	40	55	37	50	58	40	55	58	72	80	88	
SINUS PENTA 0049	22	30	71	37	50	67	45	60	70	45	60	64	80	96	115	
Size S20																
SINUS PENTA 0060	25	35	80	45	60	80	55	75	85	55	75	78	88	112	134	
SINUS PENTA 0067	30	40	96	55	75	98	60	80	91	65	90	88	103	118	142	
SINUS PENTA 0074	37	50	117	65	90	114	70	95	107	75	100	103	120	144	173	
SINUS PENTA 0086	40	55	127	75	100	133	75	100	116	85	115	120	135	155	186	
Size S30																
SINUS PENTA 0113	45	60	135	90	125	159	90	125	135	90	125	127	180	200	240	
SINUS PENTA 0129	55	75	170	100	135	180	110	150	166	110	150	153	195	215	258	
SINUS PENTA 0150	65	90	195	110	150	191	132	180	198	150	200	211	215	270	324	
SINUS PENTA 0162	75	100	231	132	180	228	150	200	230	160	220	218	240	290	324	
Inverter power supply	200-240 Vac; 280-340 Vdc			380-500 Vac; 530-705 Vdc												

1) Unavailable model as IP54 - 2) Cabinet version only available on demand - 3) Input reactor and output reactor required.

Key Inom= inverter nominal current • Imax= inverter maximum current for 120sec every 20min. up to S30 and 60sec. every 10min. >=S41 • Ipeak= inverter maximum current for 3sec
Note: The indicated motor currents refer to standard 4 pole motors, with IE2 efficiency

STANDARD OVERLOAD UP TO 140% (60s) OR UP TO 168% (3s)
Power supply up to 500 Vac

Sinus Penta Model	2T						4T						Inom.	Imax	Ipeak (3s)	
	200-240 Vac			380-415 Vac			440-460 Vac			480-500 Vac						
	kW	CV	A	kW	CV	A	kW	CV	A	kW	CV	A				A
Size S41																
SINUS PENTA 0180	80	110	250	160	220	273	185	250	279	200	270	273	300	340	408	
SINUS PENTA 0202	90	125	277	200	270	341	220	300	326	250	340	337	345	420	504	
SINUS PENTA 0217	110	150	332	220	300	375	250	340	375	260	350	359	375	460	552	
SINUS PENTA 0260	132	180	390	250	340	421	280	380	410	300	410	418	425	560	672	
Size S51																
SINUS PENTA 0313	150	200	458	280	380	480	315	430	459	355	485	471	480	600	720	
SINUS PENTA 0367	160	220	475	315	430	528	375	510	540	400	550	544	550	680	792	
SINUS PENTA 0402	185	250	550	400	550	680	450	610	665	500	680	673	680	850	1020	
Size S60																
SINUS PENTA 0457	220	300	661	400	550	680	450	610	665	500	680	673	720	880	1056	
SINUS PENTA 0524	260	350	780	450	610	765	500	680	731	560	770	751	800	960	1152	
Size S60P																
SINUS PENTA 0598P	-	-	-	500	680	841	560	760	817	630	860	864	900	1100	1152	
Size S65³⁾																
SINUS PENTA 0598	-	-	-	500	680	841	560	760	817	630	860	864	900	1100	1320	
SINUS PENTA 0748	-	-	-	560	760	939	630	860	939	710	970	960	1000	1300	1560	
SINUS PENTA 0831	-	-	-	630	860	1080	800	1090	1160	800	1090	1067	1200	1440	1728	
Size S75²⁾																
SINUS PENTA 0964	-	-	-	800	1090	1334	900	1230	1287	1000	1360	1317	1480	1780	2136	
SINUS PENTA 1130	-	-	-	900	1230	1480	1100	1500	1630	1170	1600	1570	1700	2040	2448	
SINUS PENTA 1296	-	-	-	1200	1650	2050	1400	1830	2000	1460	1990	2050	2100	2520	3024	
Size S90²⁾																
SINUS PENTA 1800	-	-	-	1400	1910	2400	1700	2300	2400	1750	2400	2400	2600	3100	3720	
SINUS PENTA 2076	-	-	-	1750	2400	2900	2000	2720	2900	2100	2900	2900	3000	3600	4000	
Inverter power supply	200-240 Vac; 280-340 Vdc						380-500 Vac; 530-705 Vdc									

SINUS PENTA IN PARALLEL

Sinus Penta Model	2T						4T						Inom.	Imax	Ipeak (3s)	
	200-240 Vac			380-415 Vac			440-460 Vac			480-500 Vac						
	kW	CV	A	kW	CV	A	kW	CV	A	kW	CV	A				A
Size S43 (2xS41)³⁾																
SINUS PENTA 0523	260	350	780	450	610	765	500	680	731	560	770	751	800	960	-	
Size S53 (2xS51)³⁾																
SINUS PENTA 0599	-	-	-	500	680	841	560	760	817	630	860	864	900	1100	-	
SINUS PENTA 0749	-	-	-	560	760	939	630	860	939	710	970	960	1000	1300	-	
SINUS PENTA 0832	-	-	-	630	860	1080	800	1090	1160	800	1090	1067	1200	1440	-	
Size S55 (3xS51)³⁾																
SINUS PENTA 0850	-	-	-	710	970	1200	800	1090	1160	900	1230	1184	1340	1600	-	
SINUS PENTA 0965	-	-	-	800	1090	1334	900	1230	1287	1000	1360	1317	1480	1780	-	
SINUS PENTA 1129	-	-	-	900	1230	1480	1100	1500	1630	1170	1600	1570	1700	2040	-	
Inverter power supply	200-240 Vac; 280-340 Vdc						380-500 Vac; 530-705 Vdc									

1) Unavailable model as IP54 - 2) Cabinet version only available on demand - 3) Input reactor and output reactor required.

Key Inom= inverter nominal current • Imax= inverter maximum current for 120sec every 20min. up to S30 and 60sec. every 10min. >=S41 • Ipeak= inverter maximum current for 3sec
 Note: The indicated motor currents refer to standard 4 pole motors, with IE2 efficiency

SINUS PENTA 2T/4T



HEAVY OVERLOAD UP TO 175% (120s) OR UP TO 210% (3s)
Power supply up to 500 Vac

Sinus Penta Model	2T			4T									Inom. A	Imax A	Ipeak (3s) A	
	200-240 Vac			380-415 Vac			440-460 Vac			480-500 Vac						
	kW	CV	A	kW	CV	A	kW	CV	A	kW	CV	A				
Size S05																
SINUS PENTA 0005	-	-	-	3	4	6.4	3.7	5	6.6	4.5	6	7.2	10.5	11.5	14	
SINUS PENTA 0007	1.8	2.5	7.3	4	5.5	8.4	4.5	6	7.8	5.5	7.5	9	12.5	13.5	16	
SINUS PENTA 0008	2.2	3	8.5	-	-	-	-	-	-	-	-	-	15	16	19	
SINUS PENTA 0009	-	-	-	4.5	6	9	5.5	7.5	9.7	7.5	10	11.8	16.5	17.5	19	
SINUS PENTA 0010	3	4	11.2	-	-	-	-	-	-	-	-	-	17	19	23	
SINUS PENTA 0011	-	-	-	5.5	7.5	11.2	7.5	10	12.5	9.2	12.5	14.3	16.5	21	25	
SINUS PENTA 0013	3.7	5	13.2	-	-	-	-	-	-	-	-	-	19	21	25	
SINUS PENTA 0014	-	-	-	7.5	10	14.8	9.2	12.5	15.6	11	15	16.5	16.5	25	30	
SINUS PENTA 0015	4	5.5	14.6	-	-	-	-	-	-	-	-	-	23	25	30	
SINUS PENTA 0016	4.5	6	15.7	-	-	-	-	-	-	-	-	-	27	30	36	
SINUS PENTA 0020 ¹⁾	5.5	7.5	19.5	-	-	-	-	-	-	-	-	-	30	36	43	
Size S12																
SINUS PENTA 0016	-	-	-	9.2	12.5	17.9	11	15	18.3	12.5	17	18.9	27	30	36	
SINUS PENTA 0017	-	-	-	9.2	12.5	17.9	11	15	18.3	12.5	17	18.9	30	32	37	
SINUS PENTA 0020	-	-	-	11	15	21	15	20	25	15	20	23.2	30	36	43	
SINUS PENTA 0023	7.5	10	25.7	-	-	-	-	-	-	-	-	-	38	42	51	
SINUS PENTA 0025	-	-	-	15	20	29	18.5	25	30	18.5	25	28	41	48	58	
SINUS PENTA 0030	-	-	-	18.5	25	35	22	30	36	22	30	33	41	56	67	
SINUS PENTA 0033	11	15	36	-	-	-	-	-	-	-	-	-	51	56	68	
SINUS PENTA 0034	-	-	-	22	30	41	25	35	40	28	38	41	57	63	76	
SINUS PENTA 0036	-	-	-	25	35	46	30	40	48	30	40	44	60	72	86	
SINUS PENTA 0037	15	20	50	-	-	-	-	-	-	-	-	-	65	72	83	
Size S15																
SINUS PENTA 0040	15	20	50	25	35	46	30	40	48	37	50	53	72	80	88	
SINUS PENTA 0049	18.5	25	61	30	40	55	37	50	58	45	60	64	80	96	115	
Size S20																
SINUS PENTA 0060	22	30	71	37	50	67	45	60	70	50	70	70	88	112	134	
SINUS PENTA 0067	25	35	80	45	60	80	50	70	75	55	75	78	103	118	142	
SINUS PENTA 0074	30	40	96	50	70	87	55	75	85	65	90	88	120	144	173	
SINUS PENTA 0086	32	45	103	55	75	98	65	90	100	75	100	103	135	155	186	
Size S30																
SINUS PENTA 0113	45	60	135	75	100	133	75	100	116	90	125	127	180	200	240	
SINUS PENTA 0129	50	70	150	80	110	144	90	125	135	110	150	153	195	215	258	
SINUS PENTA 0150	55	75	170	90	125	159	110	150	166	132	180	180	215	270	324	
SINUS PENTA 0162	65	90	195	110	150	191	132	180	198	140	190	191	240	290	324	
Inverter power supply	200-240 Vac; 280-340 Vdc			380-500 Vac; 530-705 Vdc												

1) Unavailable model as IP54 - 2) Cabinet version only available on demand - 3) Input reactor and output reactor required.
 Key Inom= inverter nominal current • Imax= inverter maximum current for 120sec every 20min. up to S30 and 60sec. every 10min. >=S41 • Ipeak= inverter maximum current for 3sec
 Note: The indicated motor currents refer to standard 4 pole motors, with IE2 efficiency

HEAVY OVERLOAD UP TO 175% (60s) OR UP TO 210% (3s)
Power supply up to 500 Vac

Sinus Penta Model	2T			4T									Inom.	Imax	Ipeak (3s)	
	200-240 Vac			380-415 Vac			440-460 Vac			480-500 Vac						
	kW	CV	A	kW	CV	A	kW	CV	A	kW	CV	A				A
Size S41																
SINUS PENTA 0180	75	100	231	132	180	228	160	220	237	160	220	218	300	340	408	
SINUS PENTA 0202	80	110	250	150	200	264	185	250	279	200	270	273	345	420	504	
SINUS PENTA 0217	110	150	332	185	250	321	220	300	326	220	300	300	375	460	552	
SINUS PENTA 0260	110	150	332	200	270	341	260	350	390	280	380	393	425	560	672	
Size S51																
SINUS PENTA 0313	132	180	390	220	300	375	260	350	390	300	400	413	480	600	720	
SINUS PENTA 0367	150	200	458	250	340	421	315	430	459	355	485	471	550	680	792	
SINUS PENTA 0402	160	220	475	315	430	528	375	510	540	400	550	544	680	850	1020	
Size S60																
SINUS PENTA 0457	200	270	593	315	430	528	400	550	576	450	610	612	720	880	1056	
SINUS PENTA 0524	220	300	661	355	480	589	450	610	665	500	680	673	800	960	1152	
Size S60P																
SINUS PENTA 0598P	-	-	-	400	550	680	500	680	731	560	760	751	900	1100	1152	
Size S65³⁾																
SINUS PENTA 0598	-	-	-	400	550	680	500	680	731	560	760	751	900	1100	1320	
SINUS PENTA 0748	-	-	-	500	680	841	560	760	817	630	860	864	1000	1300	1560	
SINUS PENTA 0831	-	-	-	560	760	939	630	860	939	710	970	960	1200	1440	1728	
Size S75²⁾																
SINUS PENTA 0964	-	-	-	710	970	1200	800	1090	1160	900	1230	1184	1480	1780	2136	
SINUS PENTA 1130	-	-	-	800	1090	1334	900	1230	1287	1000	1360	1317	1700	2040	2448	
SINUS PENTA 1296	-	-	-	1000	1360	1650	1100	1500	1630	1170	1600	1560	2100	2520	3024	
Size S90²⁾																
SINUS PENTA 1800	-	-	-	1200	1650	2050	1450	1970	2050	1500	2000	2050	2600	3100	3720	
SINUS PENTA 2076	-	-	-	1400	1910	2400	1700	2300	2400	1750	2400	2400	3000	3600	4000	
Inverter power supply	200-240 Vac; 280-340 Vdc			380-500 Vac; 530-705 Vdc												

SINUS PENTA IN PARALLEL

Sinus Penta Model	2T			4T									Inom.	Imax	Ipeak (3s)	
	200-240 Vac			380-415 Vac			440-460 Vac			480-500 Vac						
	kW	CV	A	kW	CV	A	kW	CV	A	kW	CV	A				A
Size S43 (2xS41)³⁾																
SINUS PENTA 0523	220	300	661	355	480	589	450	610	665	500	680	673	800	960	-	
Size S53 (2xS51)³⁾																
SINUS PENTA 0599	-	-	-	400	550	680	500	680	731	560	760	751	900	1100	-	
SINUS PENTA 0749	-	-	-	500	680	841	560	760	817	630	860	864	1000	1300	-	
SINUS PENTA 0832	-	-	-	560	760	939	630	860	939	710	970	960	1200	1440	-	
Size S55 (3xS51)³⁾																
SINUS PENTA 0850	-	-	-	630	860	1080	710	970	1043	800	1090	1067	1340	1600	-	
SINUS PENTA 0965	-	-	-	710	970	1200	800	1090	1160	900	1230	1184	1480	1780	-	
SINUS PENTA 1129	-	-	-	800	1090	1334	900	1230	1287	1000	1360	1317	1700	2040	-	
Inverter power supply	200-240 Vac; 280-340 Vdc			380-500 Vac; 530-705 Vdc												

1) Unavailable model as IP54 - 2) Cabinet version only available on demand - 3) Input reactor and output reactor required.

Key Inom= inverter nominal current • Imax= inverter maximum current for 120sec every 20min. up to S30 and 60sec. every 10min. >=S41 • Ipeak= inverter maximum current for 3sec
 Note: The indicated motor currents refer to standard 4 pole motors, with IE2 efficiency

SINUS PENTA 2T/4T



STRONG OVERLOAD UP TO 200% (120s) OR UP TO 240% (3s)
Power supply up to 500 Vac

Sinus Penta Model	2T			4T									Inom. A	Imax A	Ipeak (3s) A	
	200-240 Vac			380-415 Vac			440-460 Vac			480-500 Vac						
	kW	CV	A	kW	CV	A	kW	CV	A	kW	CV	A				
Size S05																
SINUS PENTA 0005	-	-	-	2.2	3	4.9	3	4	5.6	3.7	5	6.1	10.5	11.5	14	
SINUS PENTA 0007	1.5	2	6.1	3	4	6.4	3.7	5	6.6	4.5	6	7.2	12.5	13.5	16	
SINUS PENTA 0008	1.8	2.5	7.3	-	-	-	-	-	-	-	-	-	15	16	19	
SINUS PENTA 0009	-	-	-	4	5.5	8.4	4.5	6	7.8	5.5	7.5	9	16.5	17.5	19	
SINUS PENTA 0010	2.2	3	8.5	-	-	-	-	-	-	-	-	-	17	19	23	
SINUS PENTA 0011	-	-	-	4.5	6	9	5.5	7.5	9.7	7.5	10	11.8	16.5	21	25	
SINUS PENTA 0013	3	4	11.2	-	-	-	-	-	-	-	-	-	19	21	25	
SINUS PENTA 0014	-	-	-	5.5	7.5	11.2	7.5	10	12.5	9.2	12.5	14.3	16.5	25	30	
SINUS PENTA 0015	3.7	5	13.2	-	-	-	-	-	-	-	-	-	23	25	30	
SINUS PENTA 0016	4	5.5	14.6	-	-	-	-	-	-	-	-	-	27	30	36	
SINUS PENTA 0020 ¹⁾	4.5	6	15.7	-	-	-	-	-	-	-	-	-	30	36	43	
Size S12																
SINUS PENTA 0016	-	-	-	7.5	10	14.8	9.2	12.5	15.6	11	15	16.5	27	30	36	
SINUS PENTA 0017	-	-	--	7.5	10	14.8	9.2	12.5	15.6	12.5	17	18.9	30	32	37	
SINUS PENTA 0020	-	-	-	9.2	12.5	17.9	11	15	18.3	12.5	17	18.9	30	36	43	
SINUS PENTA 0023	5.5	7.5	19.5	-	-	-	-	-	-	-	-	-	38	42	51	
SINUS PENTA 0025	-	-	-	11	15	21	15	20	25	15	20	23.2	41	48	58	
SINUS PENTA 0030	-	-	-	15	20	29	18.5	25	30	18.5	25	28	41	56	67	
SINUS PENTA 0033	7.5	10	25.7	-	-	-	-	-	-	-	-	-	51	56	68	
SINUS PENTA 0034	-	-	-	18.5	25	35	22	30	36	22	30	33	57	63	76	
SINUS PENTA 0036	-	-	-	22	30	41	25	35	40	28	38	41	60	72	86	
SINUS PENTA 0037	11	15	36	-	-	-	-	-	-	-	-	-	65	72	83	
Size S15																
SINUS PENTA 0040	12.5	17	41	22	30	41	25	35	40	30	40	44	72	80	88	
SINUS PENTA 0049	15	20	50	25	35	46	30	40	48	37	50	53	80	96	115	
Size S20																
SINUS PENTA 0060	18.5	25	61	30	40	55	37	50	58	45	60	64	88	112	134	
SINUS PENTA 0067	20	27	66	32	45	59	40	55	63	50	70	70	103	118	142	
SINUS PENTA 0074	22	30	71	37	50	67	45	60	70	55	75	78	120	144	173	
SINUS PENTA 0086	25	35	80	45	60	80	55	75	85	65	90	88	135	155	186	
Size S30																
SINUS PENTA 0113	30	40	96	55	75	98	65	88	100	75	100	103	180	200	240	
SINUS PENTA 0129	37	50	117	65	90	114	75	100	116	85	115	120	195	215	258	
SINUS PENTA 0150	45	60	135	75	100	133	90	125	135	90	125	127	215	270	324	
SINUS PENTA 0162	55	75	170	90	125	159	110	150	166	110	150	153	240	290	324	
Inverter power supply	200-240 Vac; 280-340 Vdc			380-500 Vac; 530-705 Vdc												

1) Unavailable model as IP54 - 2) Cabinet version only available on demand - 3) Input reactor and output reactor required.
 Key Inom= inverter nominal current • Imax= inverter maximum current for 120sec every 20min. up to S30 and 60sec. every 10min. >=S41 • Ipeak= inverter maximum current for 3sec
 Note: The indicated motor currents refer to standard 4 pole motors, with IE2 efficiency

STRONG OVERLOAD UP TO 200% (60s) OR UP TO 240% (3s)
Power supply up to 500 Vac

Sinus Penta Model	2T			4T									Inom. A	Imax A	Ipeak (3s) A
	200-240 Vac			380-415 Vac			440-460 Vac			480-500 Vac					
	kW	CV	A	kW	CV	A	kW	CV	A	kW	CV	A			
Size S41															
SINUS PENTA 0180	60	85	185	110	150	191	120	165	184	132	180	180	300	340	408
SINUS PENTA 0202	65	90	195	132	180	228	150	200	230	160	220	218	345	420	504
SINUS PENTA 0217	75	100	231	150	200	260	160	220	245	185	250	257	375	460	552
SINUS PENTA 0260	90	125	277	160	220	273	200	270	307	200	270	273	425	560	672
Size S51															
SINUS PENTA 0313	110	150	332	185	250	321	220	300	326	250	340	337	480	600	720
SINUS PENTA 0367	120	165	375	200	270	341	250	340	366	260	350	359	550	680	792
SINUS PENTA 0402	132	180	390	280	380	480	315	430	462	355	480	471	680	850	1020
Size S60															
SINUS PENTA 0457	160	220	475	280	380	480	330	450	493	375	510	497	720	880	1056
SINUS PENTA 0524	185	250	550	315	430	528	375	510	540	400	550	544	800	960	1152
Size S60P															
SINUS PENTA 0598P	-	-	-	355	480	589	400	550	591	450	610	612	900	1100	1152
Size S65³⁾															
SINUS PENTA 0598	-	-	-	355	480	589	400	550	591	450	610	612	900	1100	1320
SINUS PENTA 0748	-	-	-	400	550	680	500	680	731	560	760	751	1000	1300	1560
SINUS PENTA 0831	-	-	-	450	610	765	560	760	817	630	860	864	1200	1440	1728
Size S75²⁾															
SINUS PENTA 0964	-	-	-	560	770	939	710	970	1043	800	1090	1067	1480	1780	2136
SINUS PENTA 1130	-	-	-	710	970	1200	800	1090	1160	900	1230	1184	1700	2040	2448
SINUS PENTA 1296	-	-	-	800	1090	1334	900	1230	1287	1000	1360	1317	2100	2520	3024
Size S90²⁾															
SINUS PENTA 1800	-	-	-	1000	1360	1650	1170	1600	1650	1200	1650	1650	2600	3100	3720
SINUS PENTA 2076	-	-	-	1200	1650	2050	1450	1970	2050	1500	2000	2050	3000	3600	4000
Inverter power supply	200-240 Vac; 280-340 Vdc						380-500 Vac; 530-705 Vdc								

SINUS PENTA IN PARALLEL

Sinus Penta Model	2T			4T									Inom. A	Imax A	Ipeak (3s) A
	200-240 Vac			380-415 Vac			440-460 Vac			480-500 Vac					
	kW	CV	A	kW	CV	A	kW	CV	A	kW	CV	A			
Size S43 (2xS41)³⁾															
SINUS PENTA 0523	185	250	550	315	430	528	375	510	540	400	550	544	800	960	-
Size S53 (2xS51)³⁾															
SINUS PENTA 0599	-	-	-	355	480	589	400	550	591	450	610	612	900	1100	-
SINUS PENTA 0749	-	-	-	400	550	680	500	680	731	560	760	751	1000	1300	-
SINUS PENTA 0832	-	-	-	450	610	765	560	760	817	630	860	864	1200	1440	-
Size S55 (3xS51)³⁾															
SINUS PENTA 0850	-	-	-	500	680	841	630	860	939	710	970	960	1340	1600	-
SINUS PENTA 0965	-	-	-	560	770	939	710	970	1043	800	1090	1067	1480	1780	-
SINUS PENTA 1129	-	-	-	710	970	1200	800	1090	1160	900	1230	1184	1700	2040	-
Inverter power supply	200-240 Vac; 280-340 Vdc						380-500 Vac; 530-705 Vdc								

1) Unavailable model as IP54 - 2) Cabinet version only available on demand - 3) Input reactor and output reactor required.

Key Inom= inverter nominal current • Imax= inverter maximum current for 120sec every 20min. up to S30 and 60sec. every 10min. >=S41 • Ipeak= inverter maximum current for 3sec
 Note: The indicated motor currents refer to standard 4 pole motors, with IE2 efficiency

SINUS PENTA 2T/4T



SINUS PENTA IP54 models

- The Sinus series also features an IP54-range suitable for environmental conditions with a strong presence of dust and water (up to SINUS PENTA S30).

- The robust metal enclosure is suitable for outdoor installations; therefore no electric cabinet is required.

DIMENSIONS AND WEIGHT IP54 MODELS

Size	W (mm)	H (mm)	D (mm)	Weight (kg)
S05 ¹⁾	214	577	227	15.7
S12	250	622	268	23.3
S15	288	715	366	40
S20	339	842	366	57
S30	359	1008	460	76

1) model Sinus Penta 0020 2T unavailable as IP54

IP54 Front door operation (optional)

A complete set is available for front-door operation, including a potentiometer, an emergency push-button and a key-operated selector switch.

LOCAL (LOC) Enables motor speed adjustment via the inverter keypad.

REMOTE (REM) Controls the inverter based on how it is programmed via terminal board, serial ports or fieldbus.





SINUS PENTA 5T/6T



Drives 1.3 kW to 3000 kW for:

- ***Three-phase asynchronous motor control***
- ***Three-phase synchronous motor control***
- ***Regeneration into the grid***

- Wide power supply AC voltage range, 500÷690 Vac
- DC power supply range 705÷970 Vdc
- Input frequency 50-60 Hz
- Available in cabinet up to 3000 kW
- Enclosure IP00, IP20, IP54
- Full compatibility with the "REMOTE DRIVE" software for remote control

SUPPLY VOLTAGE
5T = 500-600 VAC
6T = 575-690 VAC

**3 YEARS
WARRANTY**

TECHNICAL HIGHLIGHTS

One product, 5 integrated functions:

- **IFD** (Inverter Frequency Drive): vector modulation function for general-purpose applications (V/F pattern).
- **VTC** (Vector Torque Control): sensorless vector function for high-torque demanding applications.
- **FOC** (Field Oriented Control): vector function with encoder for high torque precision and wide speed range.
- **SYN** (Synchronous): vector function for brushless synchronous motors with permanent magnets, high torque precision joined to high energy efficiency level.
- **RGN** (Regenerative): sinusoidal power factor $\cos \phi = 1$, AC/DC feeder function for direct supply of a series of drives.
- Extremely compact dimensions: one of the best current density [A/m³] in the market.
- Widest range of STANDARD I/O.
- Most encoder input directly to control board, no option board required for FOC control.
- Open loop speed precision: $\pm 0.5\%$ of max. speed. Closed loop (with an encoder) speed precision: $< 0.01\%$ of max. speed.
- Intelligent cooling system. Through-Hole mounting, segregation of forced air flow channels.
- Integrated braking chopper up to S32 at 100% nominal current.
- Programmable logic blocks.
- Regulation of output frequency from 0 to 1000 Hz (depending on models).
- Lower motor noise with random modulation and carrier frequency up to 16 kHz (depending on models).
- Integrated EMC filters on the full range in compliance with EN61800-3 2nd ed.
- INTEGRATED INPUT FILTERS, EMC EN61800-3, 2nd edition, SECOND ENVIRONMENT Category C3, EN55011 gr.2 cl. A, for industrial environments
- STO (Safe Torque Off) Function in compliance with EN 61800-5-2 SIL 3, EN ISO 13849 PL d.
- Designed according to IEC 60721-3-3, category 3C2.

TECHNICAL FEATURES

SINUS PENTA inverters fit any application thanks to their advanced features, among which: vector modulation; power control with the latest IGBTs; high immunity to radio interference; high overload capability.

- Easy commissioning with pre-set parameters for the most common applications. Special application "multi-pump".
- Operating parameters saved to removable keypad or PC and possibility of parameter transfer to multiple inverters.
- Control panel with 12 keys and large back-lit LCD.
- Automatic calibration for motor parameters tuning.
- Programmable multiple acceleration and deceleration ramps. Programmable S ramps.
- Automatic DC braking.
- Motor PTC thermal probe control. Integrated motor thermal protection.
 - In case of power failure, total control of the motor, down to 0 RPM.
- Master-slave function for the operation of several motors connected to the same drive shaft (VTC and FOC).
- 200% max torque.
- PID Function / Second PID Function / 2-zone PID.
- Skip frequency.
- Integrated digital potentiometer. Integrated multifunctional tester.
- Fire Mode function available.
- Trip Log.
- STANDARD I/Os:
 - Encoder feedback
 - 8 programmable inputs and MPL logic
 - 3 programmable analog inputs 0-10 Vdc, 0(4)-20 mA, PTC
 - 4 programmable digital output (2 relays with exchange contact, 1 open-collector, 1 Push-Pull)
 - Auxiliary input frequency 5,000-65,000 Hz, Auxiliary output frequency 5,000-65,000 Hz
 - 3 programmable analog outputs 0-10 Vdc, 0(4)-20 mA.
- Auxiliary output voltage 24 Vdc, 10 Vdc.
- Serial communications RS485 with MODBUS RTU protocol up to 38.400 Baud.

SPECIAL CONFIGURATIONS:

- 12-pulse bridge: starting from the S42 size, it is possible to supply the drive on 12-pulse bridge configuration.
- Optional boards for Fieldbus communication, Encoder or Resolver interface, Data loggers, RTC, I/O expansion.
- Custom execution in box or cabinets with input and/or DC and/or output inductors, circuit breakers, AFE sensors and switch.

SINUS PENTA 5T/6T



TECHNICAL DATA

Connected motor power range / voltage range

3~2500 kW 525÷575 Vac 3phase
3~3000 kW 660÷690 Vac 3phase

Mains Vac supply voltage and frequency

5T 500÷600 Vac, 3phase, -15% +10% 50÷60 Hz
6T 575÷690 Vac, 3phase, -15% +10% 50÷60 Hz

DC supply voltage

5T 705÷845 Vdc
6T 815÷970 Vdc

Overvoltage category

III (refer to EN 61800-5-1)

Degree of protection/size

IP20 from size S12 to size S32,
IP00 from size S42 to size S90,
IP54 from size S12 to size S32

Ambient temperature

-10°C TO 55°C with no derating (or 2%/°C over 40°C, based on the inverter model and the application category)

Storage temperature

-25 ÷ +70°C

Humidity

5 ÷ 95% (non condensing)

Altitude

Standard max. altitude 2000 m a.s.l.
(2000 m ÷ 4000 m, on request)
Above 1000 m, derate 1%/100 m.

Vibrations

Lower than 9.8 m/sec² (= 1.0G)

Installation environment

No direct sunlight, conductive dust, corrosive gases, water sprinkling or dripping, or salty environments

Operating atmospheric pressure

86 ÷ 106 kPa

Cooling system

Forced air-cooling

Environmental conditions

Designed according to the guidelines of IEC 60721-3-3, category 3C2



DIMENSIONS AND WEIGHT IP20 - IP00 MODELS

Size	W (mm)	H (mm)	D (mm)	Weight (kg)
S12	215	401	225	12.5
S14	270	530	250	23
S22	282.5	813.5	353	52
S32	366.5	881	399	84
S42	500	968	409	136
S52	578	968	409	160
S65	980	1400	560	440
S70	1230	1400	960	440



SINUS PENTA 5T/6T



LIGHT OVERLOAD UP TO 120% (60s) OR UP TO 144% (3s)
Power supply up to 690 Vac

Sinus Penta Model	5T			6T			Inom.	Imax	Ipeak (3s)
	525-575vac			660-690 Vac					
	kW	CV	A	kW	CV	A			
Size S12									
SINUS PENTA 0003	4	5.5	5.7	5.5	7.5	6.3	7	8.5	10
SINUS PENTA 0004	5.5	7.5	7.6	7.5	10	8.4	9	11	13
SINUS PENTA 0006	7.5	10	10	9.2	12.5	10.2	11	13.5	16
SINUS PENTA 0012	9.2	12.5	12.5	11	15	12.1	13	16	19
SINUS PENTA 0018	11	15	14	15	20	16.8	17	21	25
Size S14									
SINUS PENTA 0003	4	5.5	5.7	5.5	7.5	6.3	7	8.5	10
SINUS PENTA 0004	5.5	7.5	7.6	7.5	10	8.4	9	11	13
SINUS PENTA 0006	7.5	10	10	9.2	12.5	10.2	11	13.5	16
SINUS PENTA 0012	9.2	12.5	12.5	11	15	12.1	13	16	19
SINUS PENTA 0018	11	15	14	15	20	16.8	17	21	25
SINUS PENTA 0019	15	20	20	18.5	25	21	21	25	30
SINUS PENTA 0021	18.5	25	25	22	30	23	25	30	36
SINUS PENTA 0022	22	30	28	30	40	33	33	40	48
SINUS PENTA 0024	30	40	39	37	50	39	40	48	58
SINUS PENTA 0032 ¹⁾	37	50	47	45	60	46	52	63	76
Size S22									
SINUS PENTA 0042	45	60	55	55	75	56	60	72	86
SINUS PENTA 0051	55	75	70	75	100	78	80	96	115
SINUS PENTA 0062	65	90	83	75	100	78	85	110	132
SINUS PENTA 0069	75	100	95	90	125	94	105	135	162
Size S32									
SINUS PENTA 0076	90	125	115	110	150	113	125	165	198
SINUS PENTA 0088	110	150	138	132	180	133	150	200	240
SINUS PENTA 0131	132	180	168	160	220	158	190	250	300
SINUS PENTA 0164	160	220	198	220	300	220	230	300	360
Size S42									
SINUS PENTA 0181	220	300	275	250	340	250	305	380	420
SINUS PENTA 0201	250	340	300	315	430	310	330	420	420
SINUS PENTA 0218	300	410	358	355	485	350	360	465	560
SINUS PENTA 0259	330	450	395	400	550	390	400	560	560
Size S52									
SINUS PENTA 0290	355	485	420	450	610	440	450	600	720
SINUS PENTA 0314	400	550	480	500	680	480	500	665	798
SINUS PENTA 0368	450	610	532	560	770	544	560	720	850
SINUS PENTA 0401	560	770	630	630	860	626	640	850	850
Inverter power supply	500-600 Vac; 705-845 Vdc			575-690 Vac; 845-970 Vdc					

1) Unavailable model as IP54 - 2) Cabinet version only available on demand - 3) input reactor and output reactor required.

Key Inom= inverter nominal current • Imax= inverter maximum current for 60sec every 10min. • Ipeak= inverter maximum current for 3sec
 Note: The indicated motor currents refer to standard 4 pole motors, with IE2 efficiency

LIGHT OVERLOAD UP TO 120% (60s) OR UP TO 144% (3s)
Power supply up to 690 Vac

Sinus Penta Model	5T			6T			Inom.	Imax	Ipeak (3s)
	525-575vac			660-690 Vac					
	kW	CV	A	kW	CV	A			
Size S65³⁾									
SINUS PENTA 0457	630	860	720	710	970	696	720	880	1056
SINUS PENTA 0524	710	970	800	800	1090	773	800	960	1152
SINUS PENTA 0598	800	1090	900	900	1230	858	900	1100	1320
SINUS PENTA 0748	900	1230	1000	1000	1360	954	1000	1300	1440
Size S70³⁾									
SINUS PENTA 0831	1000	1360	1145	1240	1690	1200	1200	1440	1440
Size S75²⁾									
SINUS PENTA 0964	1270	1730	1480	1530	2090	1480	1480	1780	2136
SINUS PENTA 1130	1460	1990	1700	1750	2380	1700	1700	2040	2448
Size S80²⁾									
SINUS PENTA 1296	1750	2380	2100	2100	2860	2100	2100	2520	3024
Size S90²⁾									
SINUS PENTA 1800	2000	2720	2400	2400	3300	2400	2600	3100	3720
SINUS PENTA 2076	2500	3400	3000	3000	4000	3000	3000	3600	4000
Inverter power supply	500-600 Vac; 705-845 Vdc			575-690 Vac; 845-970 Vdc					

SINUS PENTA IN PARALLEL

Sinus Penta Model	5T			6T			Inom.	Imax	Ipeak (3s)
	575vac			660-690 Vac					
	kW	CV	A	kW	CV	A			
Size S44 (2xS42)³⁾									
SINUS PENTA 0459	630	860	720	710	970	696	720	880	-
Size S54 (2xS52)³⁾									
SINUS PENTA 0526	710	970	800	800	1090	710	800	960	-
SINUS PENTA 0600	800	1090	900	900	1230	800	900	1100	-
SINUS PENTA 0750	900	1230	1000	1000	1360	900	1000	1300	-
SINUS PENTA 0828	1000	1360	1145	1240	1690	1000	1200	1440	-
Size S56 (3xS52)³⁾									
SINUS PENTA 0960	1270	1730	1480	1530	2090	1480	1480	1780	-
SINUS PENTA 1128	1460	1990	1700	1750	2380	1700	1700	2040	-
Inverter power supply	500-600 Vac; 705-845 Vdc			575-690 Vac; 815-970 Vdc					

1)) Unavailable model as IP54 - 2) Cabinet version only available on demand - 3) input reactor and output reactor required.
 Key Inom= inverter nominal current • Imax= inverter maximum current for 60sec every 10min. • Ipeak= inverter maximum current for 3sec
 Note: The indicated motor currents refer to standard 4 pole motors, with IE2 efficiency

SINUS PENTA 5T/6T



STANDARD OVERLOAD UP TO 140% (60s) OR UP TO 168% (3s)
Power supply up to 690 Vac

Sinus Penta Model	5T			6T			Inom.	Imax	Ipeak (3s)
	525-575 Vac			660-690 Vac					
	kW	CV	A	kW	CV	A			
Size S12									
SINUS PENTA 0003	4	5.5	5.7	4	5.5	4.8	7	8.5	10
SINUS PENTA 0004	5.5	7.5	7.6	5.5	7.5	6.3	9	11	13
SINUS PENTA 0006	7.5	10	10	7.5	10	8.4	11	13.5	16
SINUS PENTA 0012	7.5	10	10	9.2	12.5	10.2	13	16	19
SINUS PENTA 0018	11	15	14	11	15	12.1	17	21	25
Size S14									
SINUS PENTA 0003	4	5.5	5.7	4	5.5	4.8	7	8.5	10
SINUS PENTA 0004	5.5	7.5	7.6	5.5	7.5	6.3	9	11	13
SINUS PENTA 0006	7.5	10	10	7.5	10	8.4	11	13.5	16
SINUS PENTA 0012	7.5	10	10	9.2	12.5	10.2	13	16	19
SINUS PENTA 0018	11	15	14	11	15	12.1	17	21	25
SINUS PENTA 0019	11	15	14	15	20	16.8	21	25	30
SINUS PENTA 0021	15	20	20	18.5	25	21	25	30	36
SINUS PENTA 0022	22	30	28	22	30	23	33	40	48
SINUS PENTA 0024	25	35	32	30	40	33	40	48	58
SINUS PENTA 0032 ¹⁾	37	50	47	37	50	39	52	63	76
Size S22									
SINUS PENTA 0042	45	60	55	45	60	46	60	72	86
SINUS PENTA 0051	55	75	70	55	75	56	80	96	115
SINUS PENTA 0062	65	90	83	75	100	77	85	110	132
SINUS PENTA 0069	75	100	95	90	125	95	105	135	162
Size S32									
SINUS PENTA 0076	90	125	115	110	150	113	125	165	198
SINUS PENTA 0088	110	150	135	132	180	133	150	200	240
SINUS PENTA 0131	132	180	168	160	220	158	190	250	300
SINUS PENTA 0164	160	220	198	200	270	198	230	300	360
Size S42									
SINUS PENTA 0181	220	300	275	250	340	250	305	380	420
SINUS PENTA 0201	250	340	300	315	430	310	330	420	420
SINUS PENTA 0218	300	410	358	315	430	310	360	465	560
SINUS PENTA 0259	330	450	395	400	550	390	400	560	560
Size S52									
SINUS PENTA 0290	355	485	420	450	610	440	450	600	720
SINUS PENTA 0314	400	550	480	450	610	440	500	665	798
SINUS PENTA 0368	450	610	532	500	680	480	560	720	850
SINUS PENTA 0401	450	610	532	630	860	626	640	850	850
Inverter power supply	500-600 Vac; 705-845 Vdc			575-690 Vac; 845-970 Vdc					

1) Unavailable model as IP54 - 2) Cabinet version only available on demand - 3) input reactor and output reactor required.
 Key Inom= inverter nominal current • Imax= inverter maximum current for 60sec every 10min. • Ipeak= inverter maximum current for 3sec
 Note: The indicated motor currents refer to standard 4 pole motors, with IE2 efficiency

STANDARD OVERLOAD UP TO 140% (60s) OR UP TO 168% (3s)
Power supply up to 690 Vac

Sinus Penta Model	5T			6T			Inom.	Imax	Ipeak (3s)
	525-575 Vac			660-690 Vac					
	kW	CV	A	kW	CV	A			
Size S65³⁾									
SINUS PENTA 0457	560	770	630	630	860	626	720	880	1056
SINUS PENTA 0524	630	860	720	710	970	696	800	960	1152
SINUS PENTA 0598	710	970	800	900	1230	858	900	1100	1320
SINUS PENTA 0748	900	1230	1000	1000	1360	954	1000	1300	1440
Size S70³⁾									
SINUS PENTA 0831	1000	1360	1145	1100	1500	1086	1200	1440	1440
Size S75²⁾									
SINUS PENTA 0964	1180	1610	1369	1410	1920	1369	1480	1780	2136
SINUS PENTA 1130	1350	1840	1569	1620	2210	1569	1700	2040	2448
Size S80²⁾									
SINUS PENTA 1296	1750	2380	2100	1850	2520	1800	2100	2520	3024
Size S90²⁾									
SINUS PENTA 1800	2000	2720	2400	2400	3300	2400	2600	3100	3720
SINUS PENTA 2076	2500	3400	3000	3000	4000	3000	3000	3600	4000
Inverter power supply	500-600 Vac; 705-845 Vdc			575-690 Vac; 845-970 Vdc					

SINUS PENTA IN PARALLEL

Sinus Penta Model	5T			6T			Inom.	Imax	Ipeak (3s)
	575 Vac			660-690 Vac					
	kW	CV	A	kW	CV	A			
Size S44 (2xS42)³⁾									
SINUS PENTA 0459	560	770	630	630	860	626	720	880	-
Size S54 (2xS52)³⁾									
SINUS PENTA 0526	630	860	720	710	970	696	800	960	-
SINUS PENTA 0600	710	970	800	900	1230	858	900	1100	-
SINUS PENTA 0750	900	1230	1000	1000	1360	954	1000	1300	-
SINUS PENTA 0828	1000	1360	1145	1100	1500	1086	1200	1440	-
Size S56 (3xS52)³⁾									
SINUS PENTA 0960	1180	1610	1369	1410	1920	1369	1480	1780	-
SINUS PENTA 1128	1350	1840	1569	1620	2210	1569	1700	2040	-
Inverter power supply	500-600 Vac; 705-845 Vdc			575-690 Vac; 815-970 Vdc					

1) Unavailable model as IP54 - 2) Cabinet version only available on demand - 3) input reactor and output reactor required.
Key Inom= inverter nominal current • Imax= inverter maximum current for 60sec every 10min. • Ipeak= inverter maximum current for 3sec
 Note: The indicated motor currents refer to standard 4 pole motors, with IE2 efficiency

SINUS PENTA 5T/6T



HEAVY OVERLOAD UP TO 175% (60s) OR UP TO 210% (3s)
Power supply up to 690 Vac

Sinus Penta Model	5T			6T			Inom.	Imax	Ipeak (3s)
	525-575 Vac			660-690 Vac					
	kW	CV	A	kW	CV	A			
Size S12									
SINUS PENTA 0003	3	4	4.4	4	5.5	4.8	7	8.5	10
SINUS PENTA 0004	4	5.5	5.7	4	5.5	4.8	9	11	13
SINUS PENTA 0006	5.5	7.5	7.6	7.5	10	8.4	11	13.5	16
SINUS PENTA 0012	7.5	10	10	7.5	10	8.4	13	16	19
SINUS PENTA 0018	9.2	12.5	12.5	11	15	12.1	17	21	25
Size S14									
SINUS PENTA 0003	3	4	4.4	4	5.5	4.8	7	8.5	10
SINUS PENTA 0004	4	5.5	5.7	4	5.5	4.8	9	11	13
SINUS PENTA 0006	5.5	7.5	7.6	7.5	10	8.4	11	13.5	16
SINUS PENTA 0012	7.5	10	10	7.5	10	8.4	13	16	19
SINUS PENTA 0018	9.2	12.5	12.5	11	15	12.1	17	21	25
SINUS PENTA 0019	11	15	14	11	15	12.1	21	25	30
SINUS PENTA 0021	15	20	20	15	20	16.8	25	30	36
SINUS PENTA 0022	18.5	25	25	22	30	23	33	40	48
SINUS PENTA 0024	22	30	28	22	30	23	40	48	58
SINUS PENTA 0032 ¹⁾	30	40	39	37	50	39	52	63	76
Size S22									
SINUS PENTA 0042	37	50	47	37	50	39	60	72	86
SINUS PENTA 0051	45	60	55	55	75	56	80	96	115
SINUS PENTA 0062	55	75	70	55	75	56	85	110	132
SINUS PENTA 0069	55	75	70	75	100	78	105	135	162
Size S32									
SINUS PENTA 0076	75	100	95	90	125	94	125	165	198
SINUS PENTA 0088	110	150	135	110	150	113	150	200	240
SINUS PENTA 0131	110	150	135	160	220	158	190	250	300
SINUS PENTA 0164	132	180	168	185	250	185	230	300	360
Size S42									
SINUS PENTA 0181	185	250	225	220	300	220	305	380	420
SINUS PENTA 0201	200	270	240	250	340	250	330	420	420
SINUS PENTA 0218	220	300	275	315	430	310	360	465	560
SINUS PENTA 0259	280	380	336	355	485	341	400	560	560
Size S52									
SINUS PENTA 0290	300	400	358	400	550	390	450	600	720
SINUS PENTA 0314	330	450	395	450	610	440	500	665	798
SINUS PENTA 0368	355	485	420	500	680	480	560	720	850
SINUS PENTA 0401	400	550	473	560	770	544	640	850	850
Inverter power supply	500-600 Vac; 705-845 Vdc			575-690 Vac; 845-970 Vdc					

1) Unavailable model as IP54 - 2) Cabinet version only available on demand - 3) input reactor and output reactor required.
 Key Inom= inverter nominal current • Imax= inverter maximum current for 60sec every 10min. • Ipeak= inverter maximum current for 3sec
 Note: The indicated motor currents refer to standard 4 pole motors, with IE2 efficiency

HEAVY OVERLOAD UP TO 175% (60s) OR UP TO 210% (3s)
Power supply up to 690 Vac

Sinus Penta Model	5T			6T			Inom.	Imax	Ipeak (3s)
	525-575 Vac			660-690 Vac					
	kW	CV	A	kW	CV	A			
Size S65³⁾									
SINUS PENTA 0457	500	680	585	560	770	544	720	880	1056
SINUS PENTA 0524	560	770	630	630	860	626	800	960	1152
SINUS PENTA 0598	630	860	720	710	970	696	900	1100	1320
SINUS PENTA 0748	710	970	800	900	1230	858	1000	1300	1440
Size S70³⁾									
SINUS PENTA 0831	800	1090	900	1000	1360	954	1200	1440	1440
Size S75²⁾									
SINUS PENTA 0964	1000	1360	1145	1220	1660	1187	1480	1780	2136
SINUS PENTA 1130	1170	1600	1360	1400	1910	1360	1700	2040	2448
Size S80²⁾									
SINUS PENTA 1296	1340	1830	1560	1610	2190	1560	2100	2520	3024
Size S90²⁾									
SINUS PENTA 1800	1750	2400	2050	2100	2860	2100	2600	3100	3720
SINUS PENTA 2076	2000	2720	2400	2400	3300	2400	3000	3600	4000
Inverter power supply	500-600 Vac; 705-845 Vdc			575-690 Vac; 845-970 Vdc					

SINUS PENTA IN PARALLEL

Sinus Penta Model	5T			6T			Inom.	Imax	Ipeak (3s)
	575 Vac			660-690 Vac					
	kW	CV	A	kW	CV	A			
Size S44 (2xS42)³⁾									
SINUS PENTA 0459	500	680	585	585	770	544	720	880	-
Size S54 (2xS52)³⁾									
SINUS PENTA 0526	560	770	630	630	860	626	800	960	-
SINUS PENTA 0600	630	860	720	710	970	696	900	1100	-
SINUS PENTA 0750	710	970	800	900	1230	858	1000	1300	-
SINUS PENTA 0828	800	1090	900	1000	1360	954	1200	1440	-
Size S56 (3xS52)³⁾									
SINUS PENTA 0960	1000	1360	1145	1220	1660	1187	1480	1780	-
SINUS PENTA 1128	1170	1600	1360	1400	1910	1360	1700	2040	-
Inverter power supply	500-600 Vac; 705-845 Vdc			575-690 Vac; 815-970 Vdc					

1) Unavailable model as IP54 - 2) Cabinet version only available on demand - 3) input reactor and output reactor required.
Key Inom= inverter nominal current • Imax= inverter maximum current for 60sec every 10min. • Ipeak= inverter maximum current for 3sec
 Note: The indicated motor currents refer to standard 4 pole motors, with IE2 efficiency

SINUS PENTA 5T/6T



STRONG OVERLOAD UP TO 200% (60s) OR UP TO 240% (3s)
Power supply up to 690 Vac

Sinus Penta Model	5T			6T			Inom.	Imax	Ipeak (3s)
	525-575 Vac			660-690 Vac					
	kW	CV	A	kW	CV	A			
Size S12									
SINUS PENTA 0003	3	4	4.4	3	4	3.7	7	8.5	10
SINUS PENTA 0004	4	5.5	5.7	4	5.5	4.8	9	11	13
SINUS PENTA 0006	4	5.5	5.7	5.5	7.5	6.3	11	13.5	16
SINUS PENTA 0012	5.5	7.5	7.6	7.5	10	8.4	13	16	19
SINUS PENTA 0018	7.5	10	10	9.2	12.5	10.2	17	21	25
Size S14									
SINUS PENTA 0003	3	4	4.4	3	4	3.7	7	8.5	10
SINUS PENTA 0004	4	5.5	5.7	4	5.5	4.8	9	11	13
SINUS PENTA 0006	4	5.5	5.7	5.5	7.5	6.3	11	13.5	16
SINUS PENTA 0012	5.5	7.5	7.6	7.5	10	8.4	13	16	19
SINUS PENTA 0018	7.5	10	10	9.2	12.5	10.2	17	21	25
SINUS PENTA 0019	9.2	12.5	12.5	11	15	12	21	25	30
SINUS PENTA 0021	11	15	14	11	15	12	25	30	36
SINUS PENTA 0022	15	20	20	18.5	25	21	33	40	48
SINUS PENTA 0024	18.5	25	25	22	30	23	40	48	58
SINUS PENTA 0032 ¹⁾	25	35	32	30	40	33	52	63	76
Size S22									
SINUS PENTA 0042	30	40	39	30	40	33	60	72	86
SINUS PENTA 0051	37	50	47	45	60	46	80	96	115
SINUS PENTA 0062	45	60	55	55	75	56	85	110	132
SINUS PENTA 0069	45	60	55	55	75	56	105	135	162
Size S32									
SINUS PENTA 0076	55	75	70	75	100	77	125	165	198
SINUS PENTA 0088	75	100	95	90	125	95	150	200	240
SINUS PENTA 0131	90	125	115	110	150	115	190	250	300
SINUS PENTA 0164	110	150	138	132	180	140	230	300	360
Size S42									
SINUS PENTA 0181	160	220	198	200	270	198	305	380	420
SINUS PENTA 0201	160	220	198	220	300	220	330	420	420
SINUS PENTA 0218	200	270	240	250	340	250	360	465	560
SINUS PENTA 0259	220	300	275	315	430	310	400	560	560
Size S52									
SINUS PENTA 0290	250	340	300	355	480	341	450	600	720
SINUS PENTA 0314	280	380	336	375	510	360	500	665	798
SINUS PENTA 0368	315	430	367	400	550	390	560	720	850
SINUS PENTA 0401	355	480	410	500	680	480	640	850	850
Inverter power supply	500-600 Vac; 705-845 Vdc			575-690 Vac; 845-970 Vdc					

1) Unavailable model as IP54 - 2) Cabinet version only available on demand - 3) input reactor and output reactor required.
 Key Inom= inverter nominal current • Imax= inverter maximum current for 60sec every 10min. • Ipeak= inverter maximum current for 3sec
 Note: The indicated motor currents refer to standard 4 pole motors, with IE2 efficiency

STRONG OVERLOAD UP TO 200% (60s) OR UP TO 240% (3s)
Power supply up to 690 Vac

Sinus Penta Model	5T			6T			Inom.	Imax	Ipeak (3s)	
	525-575 Vac			660-690 Vac						
	kW	CV	A	kW	CV	A	A	A	A	
Size S65³⁾										
SINUS PENTA 0457	400	550	480	500	680	480	720	880	1056	
SINUS PENTA 0524	450	610	532	560	770	544	800	960	1152	
SINUS PENTA 0598	560	770	630	630	860	626	900	1100	1320	
SINUS PENTA 0748	630	860	720	800	1090	773	1000	1300	1440	
Size S70³⁾										
SINUS PENTA 0831	710	970	800	900	1230	858	1200	1440	1440	
Size S75²⁾										
SINUS PENTA 0964	900	1230	1000	1000	1360	954	1480	1780	2136	
SINUS PENTA 1130	1000	1360	1145	1100	1500	1086	1700	2040	2448	
Size S80²⁾										
SINUS PENTA 1296	1150	1570	1337	1380	1880	1337	2100	2520	3024	
Size S90²⁾										
SINUS PENTA 1800	1460	1990	1700	1750	2380	1700	2600	3100	3720	
SINUS PENTA 2076	1750	2400	2050	2100	2860	2100	3000	3600	4000	
Inverter power supply	500-600 Vac; 705-845 Vdc			575-690 Vac; 845-970 Vdc						

SINUS PENTA IN PARALLEL

Sinus Penta Model	5T			6T			Inom.	Imax	Ipeak (3s)	
	575 Vac			660-690 Vac						
	kW	CV	A	kW	CV	A	A	A	A	
Size S44 (2xS42)³⁾										
SINUS PENTA 0459	400	550	480	500	680	480	720	880	-	
Size S54 (2xS52)³⁾										
SINUS PENTA 0526	450	610	532	560	770	544	800	960	-	
SINUS PENTA 0600	560	770	630	630	860	626	900	1100	-	
SINUS PENTA 0750	630	860	720	800	1090	773	1000	1300	-	
SINUS PENTA 0828	710	970	800	900	1230	858	1200	1440	-	
Size S56 (3xS52)³⁾										
SINUS PENTA 0960	900	1230	1000	1000	1360	954	1480	1780	-	
SINUS PENTA 1128	1000	1360	1145	1100	1500	1086	1700	2040	-	
Inverter power supply	500-600 Vac; 705-845 Vdc			575-690 Vac; 815-970 Vdc						

1) Unavailable model as IP54 - 2) Cabinet version only available on demand - 3) input reactor and output reactor required.
 Key Inom= inverter nominal current • Imax= inverter maximum current for 60sec every 10min. • Ipeak= inverter maximum current for 3sec
 Note: The indicated motor currents refer to standard 4 pole motors, with IE2 efficiency

SINUS PENTA 5T/6T



S12



S14



S22



S32

SINUS PENTA IP54 models

- The Sinus series also features an IP54-range suitable for environmental conditions with a strong presence of dust and water (up to SINUS PENTA S32).

- The robust metal enclosure is suitable for outdoor installations, therefore no electric cabinet is required

DIMENSIONS AND WEIGHT IP54 MODELS

Size	W (mm)	H (mm)	D (mm)	Weight (kg)
S12	250	622	268	23
S14 ¹⁾	310	751	295	31
S22	345	1075	465	86
S32	431	1160	471	113

1) model Sinus Penta 0032 5T/6T unavailable as IP54

IP54 Front door operation (optional)

A complete set is available for front-door operation, including a potentiometer, an emergency push-button and a key-operated selector switch.

LOCAL (LOC) Enables motor speed adjustment via the inverter keypad.

REMOTE (REM) Controls the inverter based on how it is programmed via terminal board, serial ports or fieldbus.





PENTA MARINE 2T/4T and 5T/6T



***Inverter for marine and offshore applications
Certified by DNV***

Drives from 1.3 kW to 1750 kW with 5 functions for:

- Three-phase asynchronous motor control
- Three-phase synchronous motor control
- Regeneration into the grid
- Wide power supply AC voltage range, 200÷690 Vac
- DC power supply range 280÷970 Vdc
- Input frequency 50-60 Hz
- Enclosure IP00, IP20, IP54
- Full compatibility with the "REMOTE DRIVE" software for remote control

SUPPLY VOLTAGE
2T = 200-240 VAC
4T = 380-500 VAC
5T = 500-600 VAC
6T = 575-690 VAC

**3 YEARS
WARRANTY**



For the combination of inverter/ motor see the tables of SINUS PENTA except sizes S65, S70, S75, S80, S90



**TOP EFFICIENCY DRIVE
CDM IE2 according to
IEC 61800-9-2**

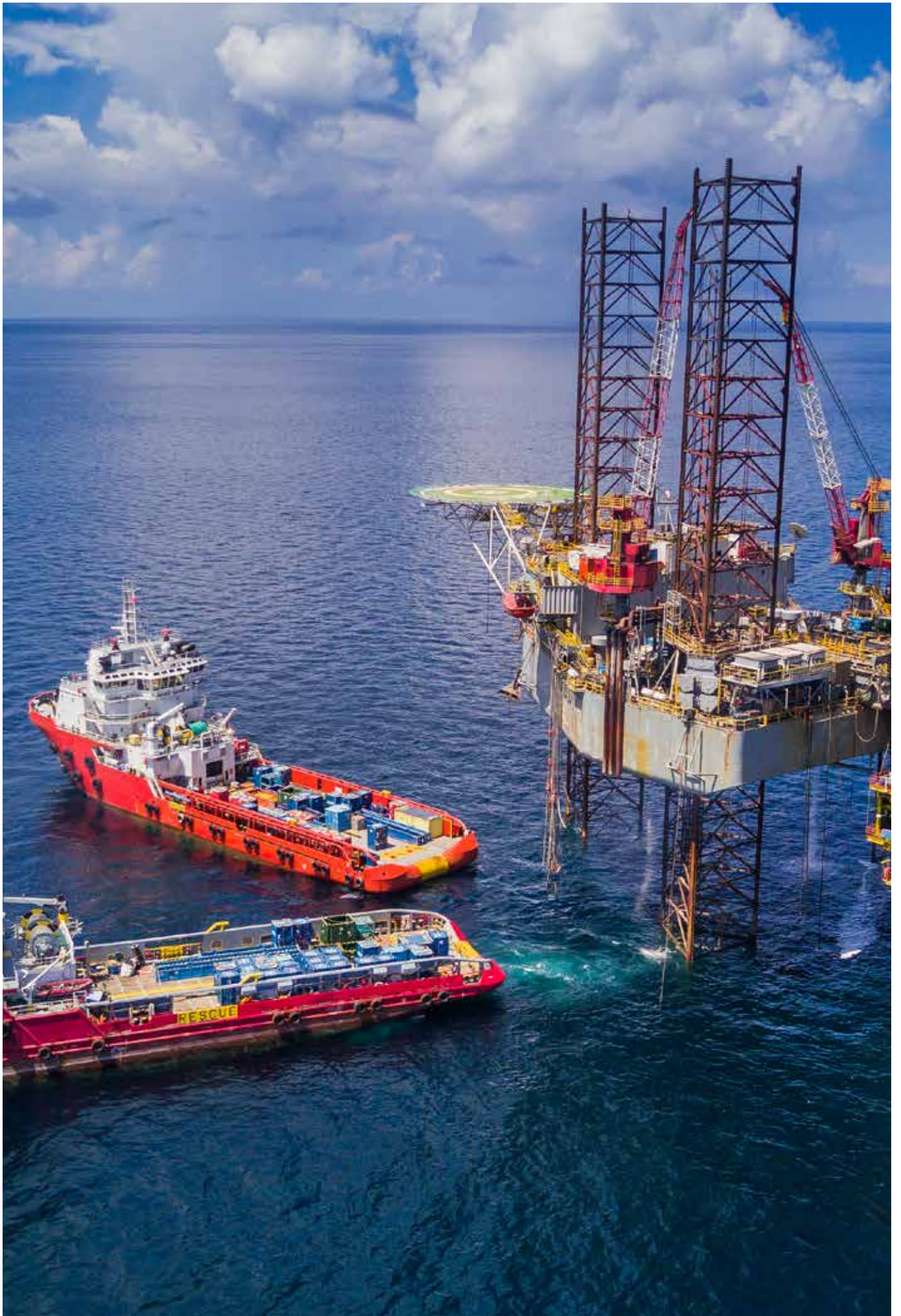

SINUS PENTA XT



SINUS PENTA XT: **"Turnkey" solution for floor installation**

The same drive controls both three-phase asynchronous and synchronous permanent magnet motors (with and without speed feedback)

Wide Power Range and two Voltage Classes

4T: 3 x 380÷500 Vac, 110÷710 kW

6T: 3 x 575÷690 Vac, 200÷1240 kW

Supply voltage tolerance: +10/-15%

- Input frequency 50 Hz
- Degree of Protection IP21, IP54

3 YEARS WARRANTY



TOP EFFICIENCY DRIVE
CDM IE2 according to
IEC 61800-9-2

MAIN FEATURES

- Compact design adaptable to customer needs
- Intuitive and multi-language control panel
- Easy access connection terminal block and internal cable tray available to the customer
- Cooling by means of separate ventilation channels:
 - Front-channel: dissipation of the control section of the drive
 - Back-channel: dissipation of the power section of the drive
- Zero clearance (side-by-side mounting)
- Three front door control modes:
 - O = BASIC
 - S = START/STOP
 - F = FULL
- SINUS PENTA XT can be configured with three input protective devices:
 - SF = Switch + Fuses 65 kA
 - CB = Circuit Breaker 10 kA
 - BF = Breaker + Fuses 65 kA

One product, 4 modes configurable by the customer



180 ° adjustable
for rear or front
air expulsion

Air intake slot that can be installed on the back or front

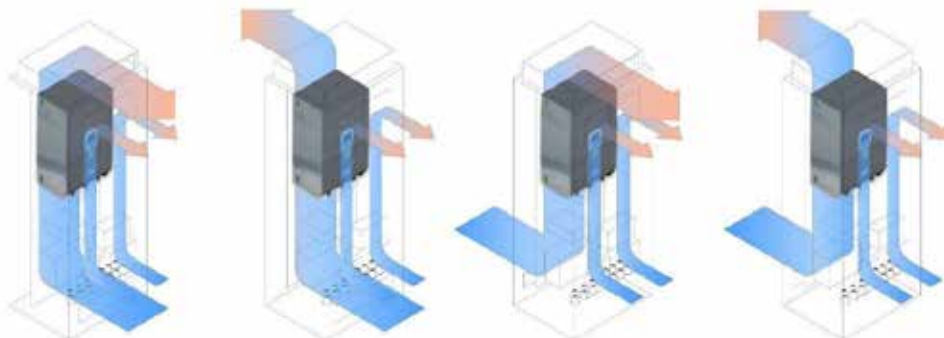

SINUS PENTA XT



SINUS PENTA XT - 4T

Model	LIGHT	STANDARD	HEAVY	STRONG	Total dimensions WxHxD
	kW	kW	kW	kW	mm
SINUS PENTA XT 0180 4T	160	160	132	110	2200 x 800 x 600
SINUS PENTA XT 0202 4T	200	200	150	132	
SINUS PENTA XT 0217 4T	220	220	185	150	
SINUS PENTA XT 0260 4T	250	250	200	160	
SINUS PENTA XT 0313 4T	280	280	220	185	2200 x 1000 x 600
SINUS PENTA XT 0367 4T	315	315	250	200	
SINUS PENTA XT 0402 4T	400	400	315	280	
SINUS PENTA XT 0523 4T	450	450	355	315	2200 x 2000 x 600
SINUS PENTA XT 0599 4T	500	500	400	355	2200 x 2600 x 600
SINUS PENTA XT 0749 4T	560	560	500	400	
SINUS PENTA XT 0832 4T	710	630	560	450	

NOTE: 1) The output power values are referred to a 400 Vac voltage feeder; 2) The kW shown in the table refer to standard motors 4 poles, efficiency class IE2.

SINUS PENTA XT - 6T

Model	LIGHT	STANDARD	HEAVY	STRONG	Total dimensions WxHxD
	kW	kW	kW	kW	mm
SINUS PENTA XT 0181 6T	250	250	220	200	2200 x 800 x 600
SINUS PENTA XT 0201 6T	315	315	250	220	
SINUS PENTA XT 0218 6T	355	315	315	250	
SINUS PENTA XT 0259 6T	400	400	355	315	
SINUS PENTA XT 0290 6T	450	450	400	355	2200 x 1000 x 600
SINUS PENTA XT 0314 6T	500	450	450	375	
SINUS PENTA XT 0368 6T	560	500	500	400	
SINUS PENTA XT 0401 6T	630	630	560	500	
SINUS PENTA XT 0459 6T	710	630	560	500	2200 x 2000 x 600
SINUS PENTA XT 0526 6T	800	710	630	560	2200 x 2600 x 600
SINUS PENTA XT 0600 6T	900	900	710	630	
SINUS PENTA XT 0750 6T	1000	1000	900	800	
SINUS PENTA XT 0828 6T	1240	1100	1000	900	

NOTE: 1) The output power values are referred to a 690 Vac voltage feeder; 2) The kW shown in the table refer to standard motors 4 poles, efficiency class IE2.

Overload available 60s every 10min:

- Light: up to 120% (up to 144% for 3s)
- Standard: up to 140% (up to 168% for 3s)
- Heavy: up to 175% (up to 210% for 3s)
- Strong: up to 200% (up to 240% for 3s)

PRODUCT SELECTION CHART

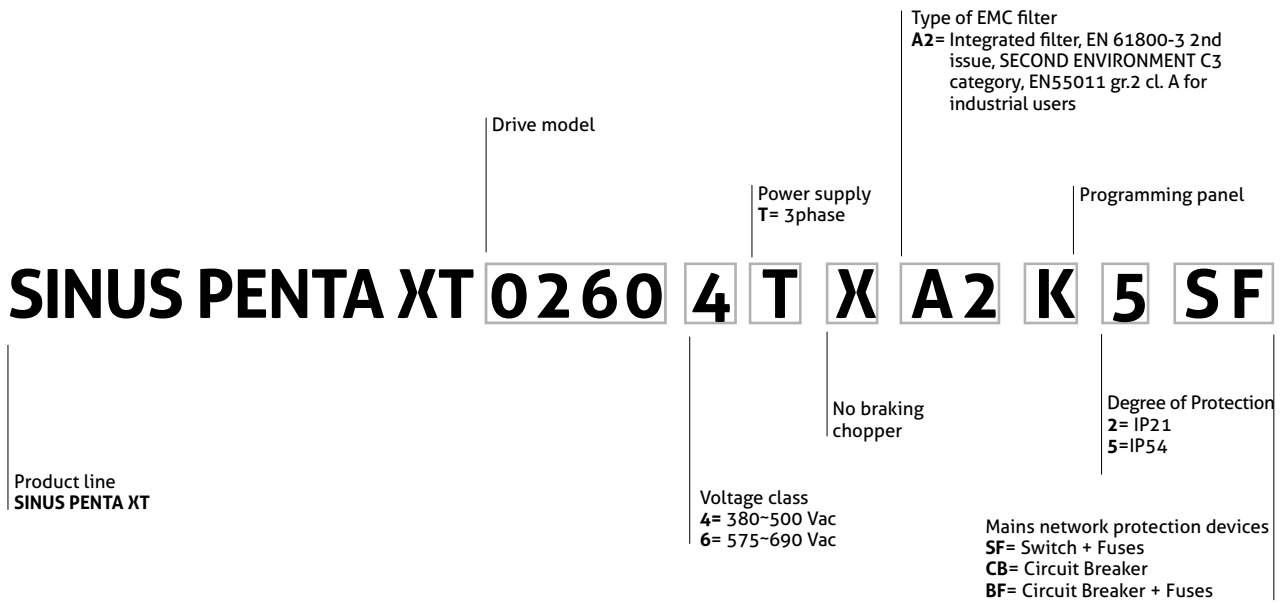

OPTIONS CONFIGURABILITY

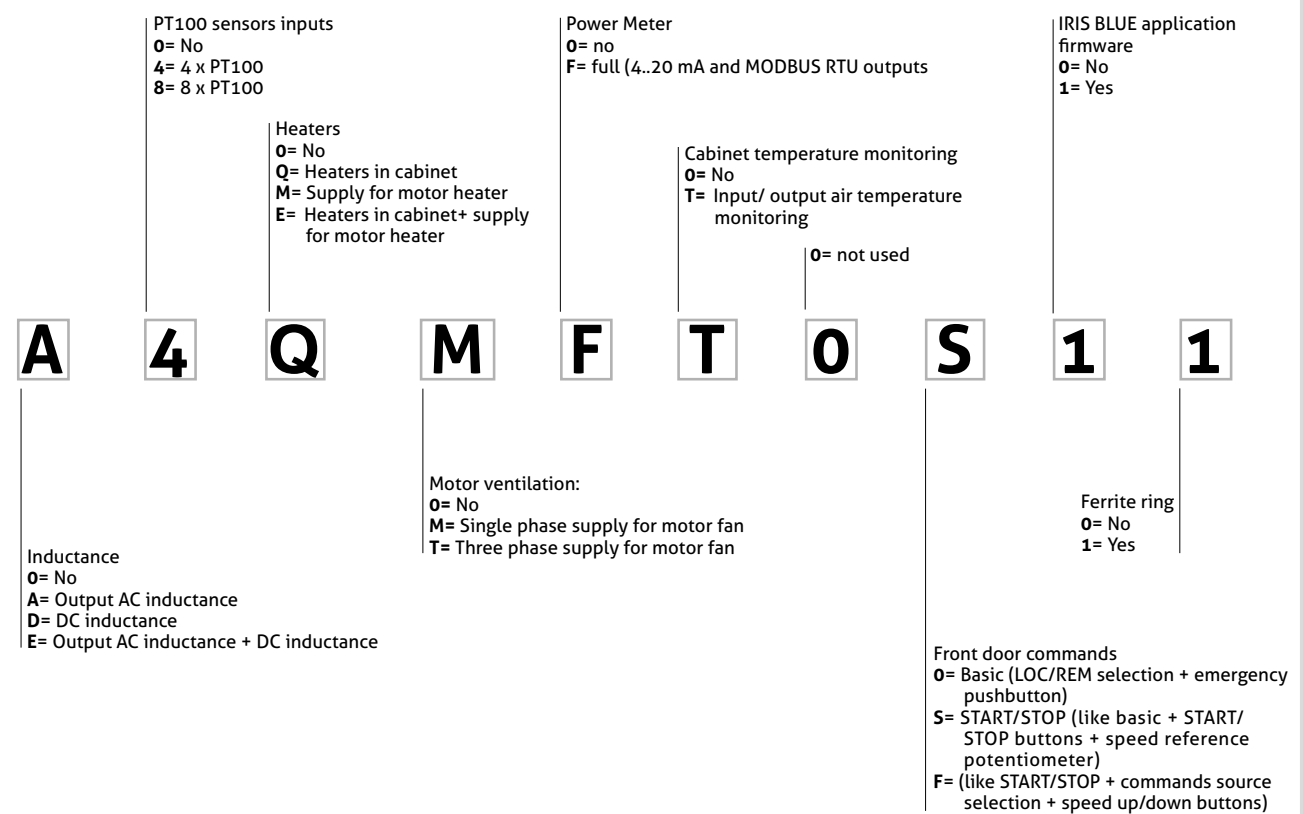

SINUS PENTA IN CABINET



3 kW to 3000 kW SINUS PENTA CABINET

on demand for:

- **Three-phase asynchronous motor control**
- **Three-phase synchronous motor control**
- **Regeneration into the grid**

- Wide power supply voltage range, 200 ÷ 690 Vac
- DC power supply range 280 ÷ 970 Vdc
- Input frequency 50 - 60 Hz
- Enclosure IP24, IP34, IP54
- Many different options available, please contact Santerno Pre-Sales office
- Full compatibility with the "REMOTE DRIVE" software for remote control

SUPPLY VOLTAGE

2T = 200-240 VAC

4T = 380-500 VAC

5T = 500-600 VAC

6T = 575-690 VAC

**3 YEARS
WARRANTY**

SINUS PENTA IN CABINET (on demand)



TECHNICAL FEATURES & HIGHLIGHTS

Sinus PENTA line inverters can be provided in cabinet. A custom made solution is given by a choice of options.

- IP24 ÷ IP54 enclosure
- Input three-pole switch with fast fuses
- Input three-pole circuit breaker
- AC1 input three-pole contactor
- Board front operation with key selector
- LOCAL/REMOTE command and EMERGENCY push-button
- Input chokes
- DC inductors
- Resonant Harmonic Filters in compliance with IEEE 519
- Motor side output chokes
- Sinusoidal filters motor-side
- EMC filters
- Supplementary terminal board for input and output cables
- Output ferrite filter
- Power supply circuit for servoventilation
- Braking module for sizes >= S41
- Internal resistor against condensation
- PT100 motor thermal probe instrument
- Front back-lit display keypad
- Special customer requests

DIMENSIONS AND WEIGHT OF THE COMPACT MODELS IN CABINET

Size	Sinus Penta Cabinet model	Voltage class	W (mm)	H (mm)	D (mm)	Weight (kg)
S15C	0040-0049	2T-4T	600	2270	500	130
S20C	0060-0067-0074-0086	2T-4T	600	2270	500	140-143
S22C	0042-0051-0062-0069	5T-6T	600	2270	500	158-161
S30C	0113-0129-0150-0162	2T-4T	600	2270	600	162
S32C	0076-0088-0131-0164	5T-6T	600	2270	600	191-195
S41C	0180-0202-0217-0260	2T-4T	1000	2270	600	280
S42C	0181-0218-0259	5T-6T	1000	2270	600	300
S51C	0313-0367-0402	2T-4T	1200	2270	600	350
S52C	0290-0314-0368-0401	5T-6T	1200	2270	600	370
S60C	0457-0524	2T-4T	1600	2675	800	586
S65C	0598-0748-0831-0457-0524-0598-0748	4T-5T-6T	2000	2675	800	854
S70C	0831	5T-6T	2200	2675	800	1007

*Dimensions and weights may change according to the required optional

SINUS PENTA IN CABINET (on demand)



Configurations, dimensions and weight

Model	Size	Voltage class (Vac)	Circuit breakers	Power supply unit	IGBT module units	Braking units	Dimensions (mm) (WxHxD)	Weight (kg)
6-PULSE Power Supply, no braking unit								
PENTA CABINET 0964 4T XA2K300	S75	380-500	1	2	6	n.d.	3600x2675x800	2580
PENTA CABINET 0964 5T/6T XA2K300		500-600 / 575-690					3600x2675x800	2600
PENTA CABINET 1130 4T XA2K300	S75	380-500	1	2	6	n.d.	3600x2675x800	2600
PENTA CABINET 1130 5T/6T XA2K300		500-600 / 575-690					3600x2675x800	2650
PENTA CABINET 1296 4T XA2K300	S80	380-500	1	3	6	n.d.	4000x2675x800	2880
PENTA CABINET 1296 5T/6T XA2K300		500-600 / 575-690					4000x2675x800	2930
PENTA CABINET 1800 4T XA2K300	S90	380-500	1	3	9	n.d.	5000x2675x800	3880
PENTA CABINET 1800 5T/6T XA2K300		500-600 / 575-690					6000x2675x800	4320
PENTA CABINET 2076 4T XA2K300	S90	380-500	1	3	9	n.d.	5000x2675x800	3900
PENTA CABINET 2076 5T/6T XA2K300		500-600 / 575-690					6000x2675x800	4340
6-PULSE Power Supply with braking unit								
PENTA CABINET 0964 4D XA2K300	S75	380-500	2	2	6	n.d.	3800x2675x800	2590
PENTA CABINET 0964 5D/6D XA2K300		500-600 / 575-690					3800x2675x800	2630
PENTA CABINET 1130 4D XA2K300	S75	380-500	2	2	6	n.d.	3800x2675x800	2590
PENTA CABINET 1130 5D/6D XA2K300		500-600 / 575-690					3800x2675x800	2680
PENTA CABINET 1296 4D XA2K300	S80	380-500	2	4	6	n.d.	4600x2675x800	3220
PENTA CABINET 1296 5D/6D XA2K300		500-600 / 575-690					5200x2675x800	3550
PENTA CABINET 1800 4D XA2K300	S90	380-500	2	4	9	n.d.	6000x2675x800	4230
PENTA CABINET 1800 5D/6D XA2K300		500-600 / 575-690					6600x2675x800	4650
PENTA CABINET 2076 4D XA2K300	S90	380-500	2	4	9	n.d.	6000x2675x800	4250
PENTA CABINET 2076 5D/6D XA2K300		500-600 / 575-690					6600x2675x800	4670
12-PULSE Power Supply, no braking unit								
PENTA CABINET 0964 4T BA2K300	S75	380-500	2	2	6	1	4000x2675x800	2740
PENTA CABINET 0964 5T/6T BA2K300		500-600V / 575-690					4000x2675x800	2930
PENTA CABINET 1130 4T BA2K300	S75	380-500	1	2	6	1	4000x2675x800	2740
PENTA CABINET 1130 5T/6T BA2K300		500-600 / 575-690					4200x2675x800	2980
PENTA CABINET 1296 4T BA2K300	S80	380-500	1	3	9	2	4600x2675x800	3150
PENTA CABINET 1296 5T/6T BA2K300		500-600 / 575-690					4600x2675x800	3260
PENTA CABINET 1800 4T BA2K300	S90	380-500	1	3	9	2	5600x2675x800	4210
PENTA CABINET 1800 5T/6T BA2K300		500-600 / 575-690					5600x2675x800	4210
PENTA CABINET 2076 4T BA2K300	S90	380-500	1	3	9	2	5600x2675x800	4230
PENTA CABINET 2076 5T/6T BA2K300		500-600 / 575-690					5600x2675x800	4230
12-PULSE Power Supply with braking unit								
PENTA CABINET 0964 4D BA2K300	S75	380-500	2	2	6	1	4200x2675x800	2770
PENTA CABINET 0964 5D/6D BA2K300		500-600 / 575-690					4400x2675x800	2650
PENTA CABINET 1130 4D BA2K300	S75	380-500	2	2	6	1	4200x2675x800	2770
PENTA CABINET 1130 5D/6D BA2K300		500-600 / 575-690					4400x2675x800	3000
PENTA CABINET 1296 4D BA2K300	S80	380-500	2	4	6	2	5200x2675x800	3400
PENTA CABINET 1296 5D/6D BA2K300		500-600 / 575-690					5200x2675x800	3550
PENTA CABINET 1800 4D BA2K300	S90	380-500	2	4	9	2	6600x2675x800	4570
PENTA CABINET 1800 5D/6D BA2K300		500-600 / 575-690					6600x2675x800	4650
PENTA CABINET 2076 4D BA2K300	S90	380-500	2	4	9	2	6600x2675x800	4590
PENTA CABINET 2076 5D/6D BA2K300		500-600 / 575-690					6600x2675x800	4670

SINUS PENTA IN CABINET (on demand)



Configurations, dimensions and weight

Model	Size	Voltage class (Vac)	Circuit breakers	Power supply unit	IGBT module units	Braking units	Dimensions (mm) (WxHxD))	Weight (kg)
Regenerative Active Front End								
PENTA CABINET RGN 0964 4C XA2K300	S74+S74	380-500	1	N.A.	6+6	n.d.	7400x2675x1000	5140
PENTA CABINET RGN 0964 5C/6C XA2K300		500-600 / 575-690					7400x2675x1000	5770
PENTA CABINET RGN 1130 4C XA2K300	S74+S74	380-500	1	N.A.	6+6	n.d.	7400x2675x1000	5140
PENTA CABINET RGN 1130 5C/6C XA2K300		500-600 / 575-690					7400x2675x1000	5770
PENTA CABINET RGN 1296 4C XA2K300	S74+S74	380-500	1	N.A.	6+6	n.d.	7400x2675x1000	5800
PENTA CABINET RGN 1296 5C/6C XA2K300		500-600 / 575-690					7400x2675x1000	5800
PENTA CABINET RGN 1800 4C XA2K300	S84+S84	380-500	1	N.A.	9+9	n.d.	10800x2675x1000	8360
PENTA CABINET RGN 1800 5C/6C XA2K300		500-600 / 575-690					10800x2675x1000	8720
PENTA CABINET RGN 2076 4C XA2K300	S84+S84	380-500	1	N.A.	9+9	n.d.	10800x2675x1000	8400
PENTA CABINET RGN 2076 5C/6C XA2K300		500-600 / 575-690					10800x2675x1000	8760



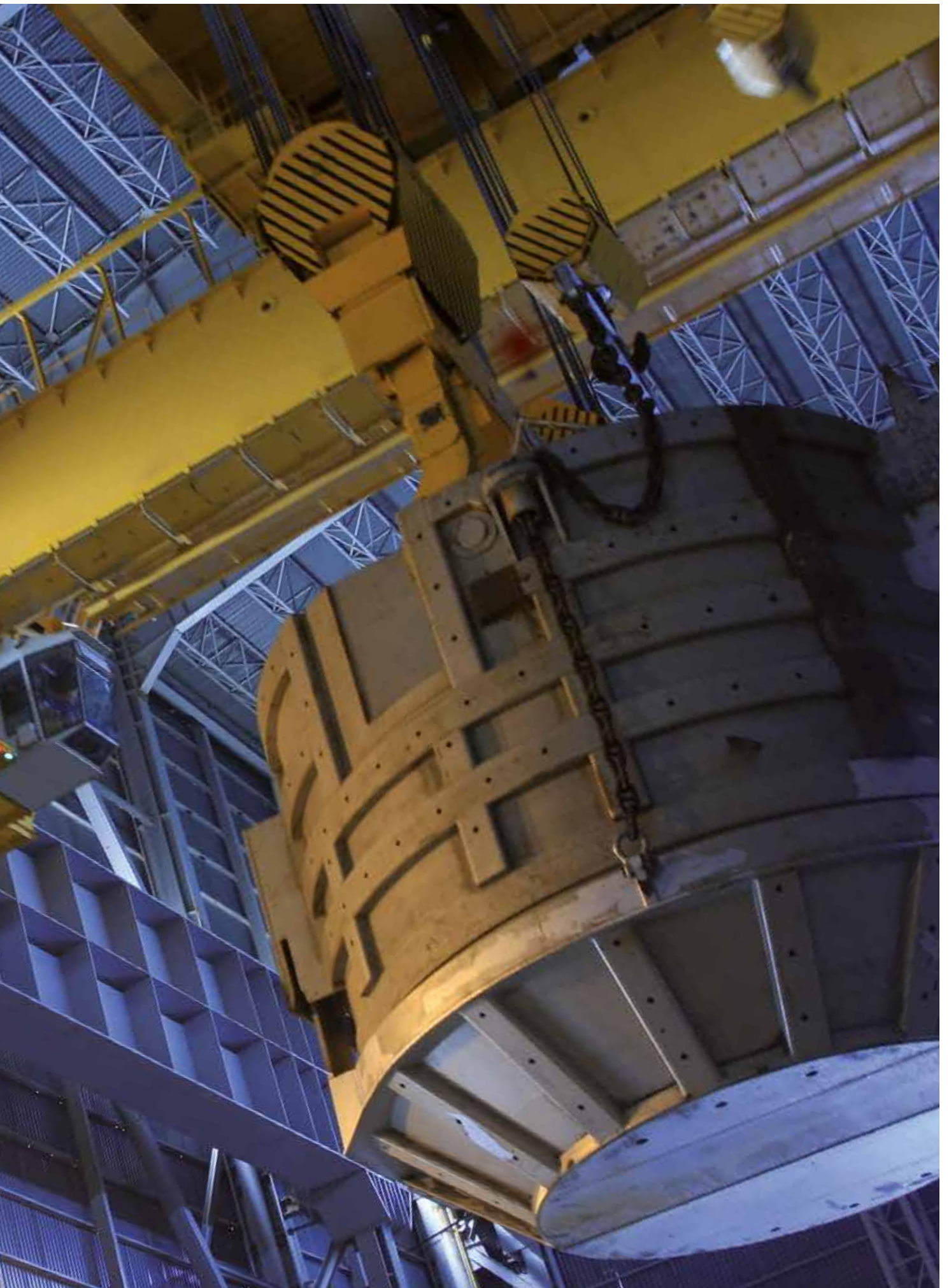

SINUS PENTA BOX IP54

WALL MOUNTING



SUPPLY VOLTAGE
2T = 200-240 VAC
4T = 380-500 VAC
5T = 500-600 VAC
6T = 575-690 VAC

3 YEARS
WARRANTY

5-function 1.3 kW to 90 kW drives in IP54 box for:

- **Three-phase asynchronous motor control**
- **Three-phase synchronous motor control**

- Wide power supply voltage range, 200 Vac - 690 Vac.
- Input frequency 50 - 60 Hz
- Power range 1.3 - 90 kW
- Full compatibility with the "REMOTE DRIVE" software for remote control

TECHNICAL FEATURES & HIGHLIGHTS

Sinus PENTA line inverters can be provided in box up to IP54 protection degree.
A custom-made solution is given by a choice of options.

- Input three pole switch circuit breaker
- AC1 input three pole contactor
- Front operation board by key selector LOCAL/REMOTE command and EMERGENCY push-button
- Input chokes
- Motor side output chokes
- Power supply circuit for servoventilation
- Internal resistor against condensation
- Supplementary terminal board for input and output cables
- Front back-lit display with keyboard

DIMENSIONS AND WEIGHTS BOX MODELS

Size	W (mm)	H (mm)	D (mm)	Weight (kg)
S05B	400	600	290	27.9
S12B	500	700	300	50.5
S15B	600	1000	400	78.2
S20B	600	1200	400	112.3

*Dimensions and weights may change according to the required optionals.

TECHNICAL FEATURES

- Intelligent cooling system. Through-Hole mounting, segregation of forced air flow channels
- Built-in EMC filters in the whole range, in compliance with EN61800-3 2nd ed, second environment category C3
- 11-key control panel and wide LCD backlit screen
- Motor PTC thermal probe control. Built-in motor thermal protection
- Built-in digital potentiometer. Built-in multifunction tester
- Programmable logic blocks
- Reduced motor noise, with random modulation and carrier frequency up to 16 kHz (depending on models)
- Measurement of the energy delivered to the pump (kWh)
- Pump working hour meter
- Saving of the operating parameters on the keypad or on a PC and possibility of transfer to multiple inverters
- Automatic calibration for motor parameter tuning
- Programmable multiple acceleration and deceleration ramps
- Controlled stop of the motor up to zero speed in the event of a power failure
- Fault list

I/O STANDARD

- 8 programmable digital inputs and MPL logic blocks
- 3 programmable analog inputs 0-10 Vdc, 0(4)-20 mA, PTC
- 4 programmable digital outputs (2 switchover relays, 1 open collector, 1 push-pull)
- 3 programmable analog outputs 0-10 Vdc, 0(4)-20 mA
- Serial RS485 communication with MODBUS RTU protocol
- Compatible with "IRIS CONTROL" software, for remote control

OPTIONS

- Input reactors to limit current peaks and reduce supply harmonic current
- du/dt output reactors to limit current peaks due to the parasitic capacitance of the cables
- IP54 Degree of Protection
- Kit for IP21 Degree of Protection
- Fieldbus and comms cards: Profinet IRT, Ethernet IP, EtherCAT, Modbus TCP, Profibus DP, DeviceNet, PROFIdrive, CANOpen
- I/O expansion cards
- Datalogger and Real Time Clock cards
- Remote control – www.hydrofast.it

POWER/VOLTAGE RANGE OF THE CONNECTED MOTOR

- 3.0~132 kW 200÷240 Vac
- 4.5~250 kW 380÷415 Vac
- 5.5~280 kW 440÷460 Vac
- 6.5~300 kW 480 Vac

VOLTAGE AND FREQUENCY OF THE MAINS VAC SUPPLY

- 2T: 200÷240 Vac, three-phase, -15% +10% 50÷60 Hz
- 4T: 380÷480 Vac, three-phase, -15% +10% 50÷60 Hz

AMBIENT TEMPERATURE

- 10 °C to 50 °C with no derating (or 2% / °C over 40 °C, based on the inverter model)

IRIS BLUE 2T/4T



PRODUCT SELECTION CHART

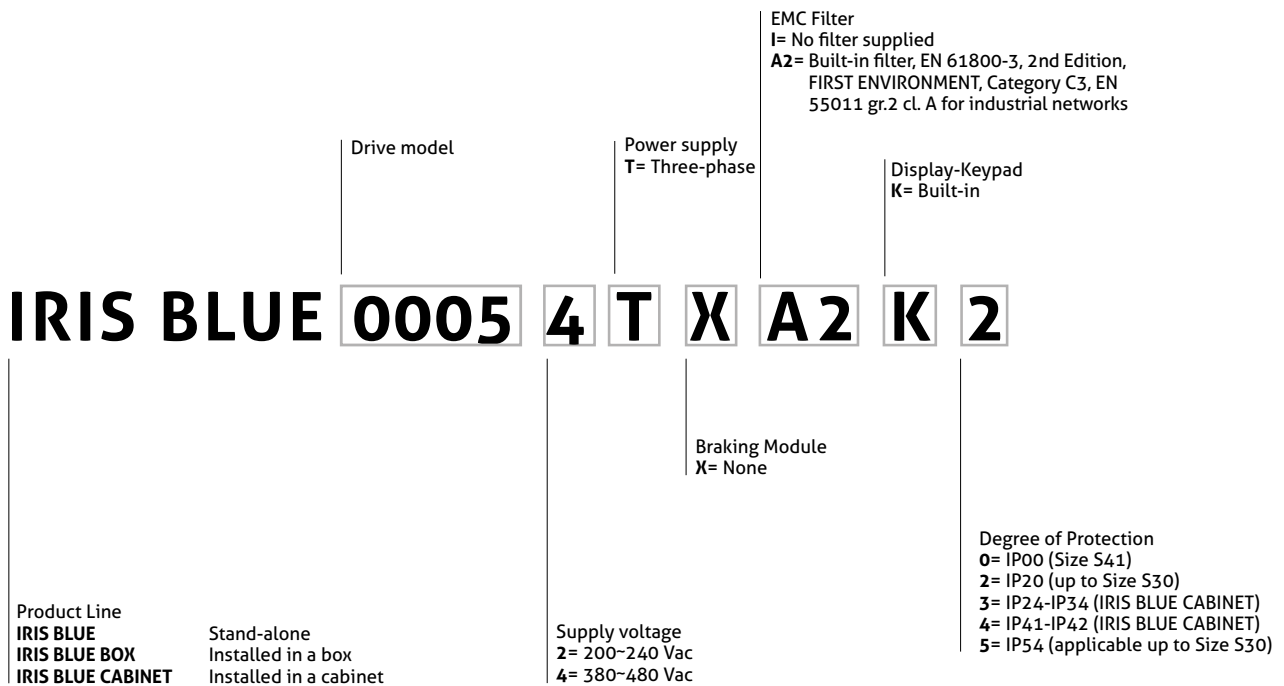

DIMENSIONS AND WEIGHTS - IP20-IP00 MODELS

Size	W (mm)	H (mm)	D (mm)	Weight (kg)
505	170	340	175	7
512	215	401	225	12.5
515	225	466	331	22.5
520	279	610	332	36
530	302	748	421	51
541	500	882	409	121

WATER - DEDICATED FUNCTIONS

The IRIS BLUE series of frequency converters is equipped with many features that allow to control in an optimal way pumping systems and water treatment processes.

DRY RUN CONTROL SYSTEM

Stop in case of lack of flow.

ADVANTAGES:

Pump protection, energy saving.

CONTROL OF THE LEVEL

Tank filling and emptying control of wastewater. The speed of the pumps will vary with the change in the demand from the utilities, which is typically diversified throughout the day.

ADVANTAGES:

Maximizes tank exchange capacity so as to ensure a stable release of EU waters to systems for their treatment.

DOUBLE RAMP (INITIAL RAMP)

The initial ramp provides rapid acceleration of the pumps up to minimum speed, after which the inverter uses the normal ramp.

ADVANTAGES:

Prevents damage to the bearings. Check of flow or sensorless pressure control. Protection of submersible pumps.

PIPE FILLING CONTROL

The soft start of the pump allows to reach gradually the desired flow rate in the pipes, avoiding pressure peaks (for example in irrigation systems, where the pipes remain temporarily empty and controlled filling is required).

ADVANTAGES:

Elimination of water hammer, increases the useful life of the distribution network and pumping system.

ALTERNATING OF MOTOR

Motor management according to demand, standardizing operative hours.

ADVANTAGES:

Redundancy, reduction of costs.

FIRE MODE

Forced operation of the converter, even in the case of alarms (for example for fire pump management).

The converter continues its regular operation even in the most extreme conditions, until possible self-destruction.

ADVANTAGES:

Safeguard of human life.

SLEEP/WAKE UP MODE

The IRIS BLUE converter is able to maintain the reference pressure even in situations where the flow demand is minimum and the pump runs at low speed. Prolongation of this condition leads to the shutdown of the pump. Pumping resumes when pressure falls below the minimum level.

ADVANTAGES:

This function prolongs the delay time of the pump and saves energy. Avoiding non-productive operation, in addition, it extends the useful life of the motor and the pump. Reduced noise level in low load situations.

MULTIPUMP

Flow, level, pressure, etc. adjustments, managing

The slave pump control according to the regulator's request (internal PID). The function allows the control of all slave pumps at fixed speed (connected to the network with remote or soft starter) or at adjustable speed. Allows balancing of pump during operating hours and cyclic exchange between pumps in service and pumps available to run. All this is possible without the aid of external equipment.

ADVANTAGES:

Water hammer and sudden pressure variations are avoided which reduce the life-time of transmission organs and control equipment fluids (pipes, valves, etc.) typical of an operation with pumps with an On/Off control.

PRESSURE LOSS

When the pump works at maximum speed without creating the desired pressure means that there are anomalies. This function detects leaks or breaks in the pipes, sending an alarm usable to stop the pump or as input for other actions.

ADVANTAGES:

Pump protection, leak monitoring.

SAFE TORQUE OFF

Function for freewheel stop with safe inhibition of motor torque. For many applications with inverter the STO function is required to proceed with the most common operations (to e.g. maintenance). This function can be achieved with additional external components (e.g. contactors) that put the system in a safe state or through the function STO integrated in the IRIS BLUE frequency converter.

ADVANTAGES:

The use of this integrated solution simplifies the design of the safety circuit and reduces installation cost and occupied space.

ENVIRONMENTAL CONDITIONS

Designed according to the guidelines of IEC 60721-3-3, Category 3C2

IRIS BLUE 2T/4T



LIGHT OVERLOAD UP TO 120% (120s) OR 144% (3s)
Power supply up to 480 Vac

IRIS BLUE Model	2T			4T									Inom. A	Imax A	Ipeak (3s) A
	200-240 Vac			380-415 Vac			440-460 Vac			480 Vac					
	kW	HP	A	kW	HP	A	kW	HP	A	kW	HP	A			
Size S05															
IRIS BLUE 0005	-	-	-	4.5	6	9	5.5	7.5	9.7	6.5	9	10.2	10.5	11.5	14
IRIS BLUE 0007	3	4	11.2	5.5	7.5	11.2	7.5	10	12.5	7.5	10	11.8	12.5	13.5	16
IRIS BLUE 0008	3.7	5	13.2	-	-	-	-	-	-	-	-	-	15	16	19
IRIS BLUE 0009	-	-	-	7.5	10	14.5	9.2	12.5	16	9.2	12.5	14.3	16.5	17.5	19
IRIS BLUE 0010	4	5.5	14.6	-	-	-	-	-	-	-	-	-	17	19	23
IRIS BLUE 0011	-	-	-	7.5	10	14.8	9.2	12.5	16	11	15	16.5	16.5	21	25
IRIS BLUE 0013	4.5	6	15.7	-	-	-	-	-	-	-	-	-	19	21	25
IRIS BLUE 0014	-	-	-	7.5	10	14.8	9.2	12.5	16	11	15	16.5	16.5	25	30
IRIS BLUE 0015	5.5	7.5	19.5	-	-	-	-	-	-	-	-	-	23	25	30
IRIS BLUE 0016	7.5	10	25.7	-	-	-	-	-	-	-	-	-	27	30	36
IRIS BLUE 0020	9.2	12.5	30	-	-	-	-	-	-	-	-	-	30	36	43
Size S12															
IRIS BLUE 0016	-	-	-	11	15	21	15	20	25	15	20	23.2	27	30	36
IRIS BLUE 0017	-	-	-	15	20	29	18.5	25	30	18.5	25	28	30	32	37
IRIS BLUE 0020	-	-	-	15	20	29	18.5	25	30	18.5	25	28	30	36	43
IRIS BLUE 0023	11	15	36	-	-	-	-	-	-	-	-	-	38	42	51
IRIS BLUE 0025	-	-	-	22	30	41	22	30	36	22	30	33	41	48	58
IRIS BLUE 0030	-	-	-	22	30	41	22	30	36	25	35	37	45	56	67
IRIS BLUE 0033	15	20	50	-	-	-	-	-	-	-	-	-	51	56	68
IRIS BLUE 0034	-	-	-	30	40	55	30	40	48	37	50	53	57	63	76
IRIS BLUE 0036	-	-	-	30	40	55	37	50	58	37	50	53	60	72	86
IRIS BLUE 0037	18.5	25	61	-	-	-	-	-	-	-	-	-	65	72	83
Size S15															
IRIS BLUE 0040	22	30	71	37	50	67	45	60	70	50	70	70	72	80	88
IRIS BLUE 0049	25	35	80	45	60	80	50	65	75	55	75	78	80	96	115
Size S20															
IRIS BLUE 0060	28	38	88	50	70	87	55	75	85	65	90	88	88	112	134
IRIS BLUE 0067	30	40	96	55	75	98	65	90	100	75	100	103	103	118	142
IRIS BLUE 0074	37	50	117	65	90	114	75	100	116	85	115	120	120	144	173
IRIS BLUE 0086	45	60	135	75	100	133	90	125	135	90	125	127	145	155	186
Size S30															
IRIS BLUE 0113	55	75	170	100	135	180	110	150	166	132	180	180	180	200	240
IRIS BLUE 0129	65	90	195	110	150	191	125	170	192	140	190	195	195	215	258
IRIS BLUE 0150	70	95	213	120	165	212	132	180	198	150	200	211	215	270	324
IRIS BLUE 0162	75	100	231	132	180	228	150	200	230	175	238	240	240	290	324
Size S41															
IRIS BLUE 0180	90	125	277	160	220	273	200	270	297	220	300	300	300	340	408
IRIS BLUE 0202	110	150	332	200	270	341	220	300	326	250	340	337	345	420	504
IRIS BLUE 0217	120	165	375	220	300	375	250	340	366	260	350	359	375	460	552
IRIS BLUE 0260	132	180	390	250	340	421	280	380	410	300	410	418	445	560	672
Drive Power Supply	200-240 Vac			380-480 Vac											

Note: Motor current ratings relate to IE2-efficiency, 4-pole standard motors

IRIS BLUE IP54 MODELS

- The IRIS BLUE product line features a whole range of IP54 models suitable for environments characterized by a strong presence of dust and water (up to IRIS BLUE S30).
- The robust metal enclosure fits outdoor installation requiring no cabinet.

DIMENSIONS AND WEIGHTS - IP54 MODELS

Size	W (mm)	H (mm)	D(mm)	Weight (kg)
505 *	214	577	227	15.7
512	250	622	268	23.3
515	288	715	366	40
520	339	842	366	57
530	359	1008	460	76

* The IRIS BLUE 0020 2T model is not available with degree of protection IP54

SOLARDRIVE PLUS/BOX/CABINET



**30 YEARS OF EXPERIENCE
IN THE PRODUCTION
OF INVERTERS FOR SOLAR PUMPING**

FEATURES

The inverters of the SOLARDRIVE PLUS line

- Guarantee maximum performance and efficiency in all conditions of irradiation thanks to the proprietary MPPT algorithm (Maximum Power Point Tracking).
- Start automatically during daylight hours.
- May be supplied by a generator set or grid during nocturnal hours.
- Regulate the water level in the tank or the water pressure in the pipes.
- Are applicable to all types of pumps.

They are available in different types:

- **SOLARDRIVE PLUS** for installation inside electrical panels at the customer's discretion.
- **SOLARDRIVE PLUS IP54** for wall installation with IP54 protection degree.
- **SOLARDRIVE PLUS/BOX/CABINET (turnkey solutions):** equipped with components for connection to the field and for connection to the pump and system protection.

Certifications CE, RoHS

Advanced pre-sale technical support for full system sizing

A range for all needs:

Range	Photovoltaic field		Motor	
	V_{MPP}	V_{oc}	Voltage	Power
Voltage class:	V_{dc}	V_{dc}	V_{ac}	kW
2T	270 ÷ 360	440	230	3 ÷ 200
4T	450 ÷ 780	830	400	3 ÷ 400 *
6T	550 ÷ 900	1200	400 ÷ 690	3 ÷ 630 **

* upon request up to 2,1 MW - ** upon request up to 3 MW

INDUCTORS

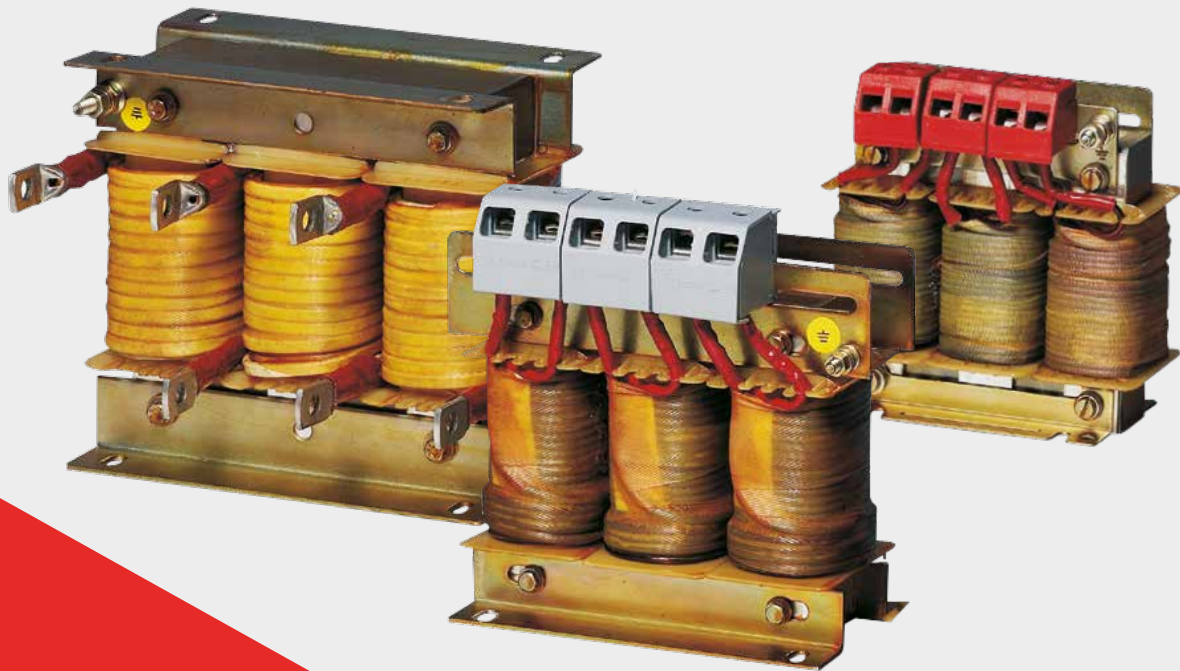

*Input Inductors and DC Inductors
(reducing mains-side harmonics)
Resonant Harmonic Filters in compliance with IEEE 519*

*Output Inductors (reducing dV/dt on motor side)
Sinusoidal Output Filters*

THE INPUT INDUCTORS AND DC INDUCTORS

- limit input current peaks to the rectifier circuit in the drive and the capacitive load of the capacitors
- reduce power supply harmonic current
- increase power factor, thus reducing line current
- increase lifetime of the capacitors within the inverter

THE RESONANT HARMONIC FILTERS

- enhance performance of input inductors and DC inductors
- ensure that the drive operation is compliant with the harmonics levels as per IEEE 519 (THDI < 5%)

THE OUTPUT INDUCTORS (dV/dt)

- reduce eddy current at the drive terminals
- reduce dV/dt on the motor windings
- reduce shaft currents on the motor
- reduce EMC conducted disturbance
- reduce the current ripple on the motor caused by the drive PWM

THE SINUSOIDAL OUTPUT FILTERS

- suppress eddy current at the drive terminals
- suppress dV/dt on the motor windings
- suppress the current ripple on the motor caused by the drive PWM
- dramatically reduce motor noise
- allow supplying the transformer inverter in step-up configuration

HARMONIC CURRENTS

Harmonic currents are produced by non-linear loads absorbing non-sinusoidal current from the mains. Typical sources are diode bridge rectifiers (inverter input stage), switch-mode power supplies and fluorescent lamps. These devices absorb line current with harmonic content $n = 6k \pm 1$ with $k = 1, 2, 3, \dots$ (e.g. 5th, 7th, 11th, 13th, 17th, 19th, etc.). The amplitude of the harmonic current decreases when frequency increases.

Harmonic current carries no active power: it is just additional current carried by electric cables. Typical effects are conductor overload, reduction of the power factor, and instability of measurement systems. The voltage produced by current flowing through the transformer reactor may also damage other equipment or interfere with switching devices synchronized with the mains.

SANTERNO MOTOR DRIVES

Santerno Motor Drives are specifically designed to reduce line harmonics, thanks to the balanced dimensioning of the DC capacitors, the rectifier diodes and the inductors in the input EMI filter.

AC input inductors and DC inductors can be installed to further reduce harmonics.

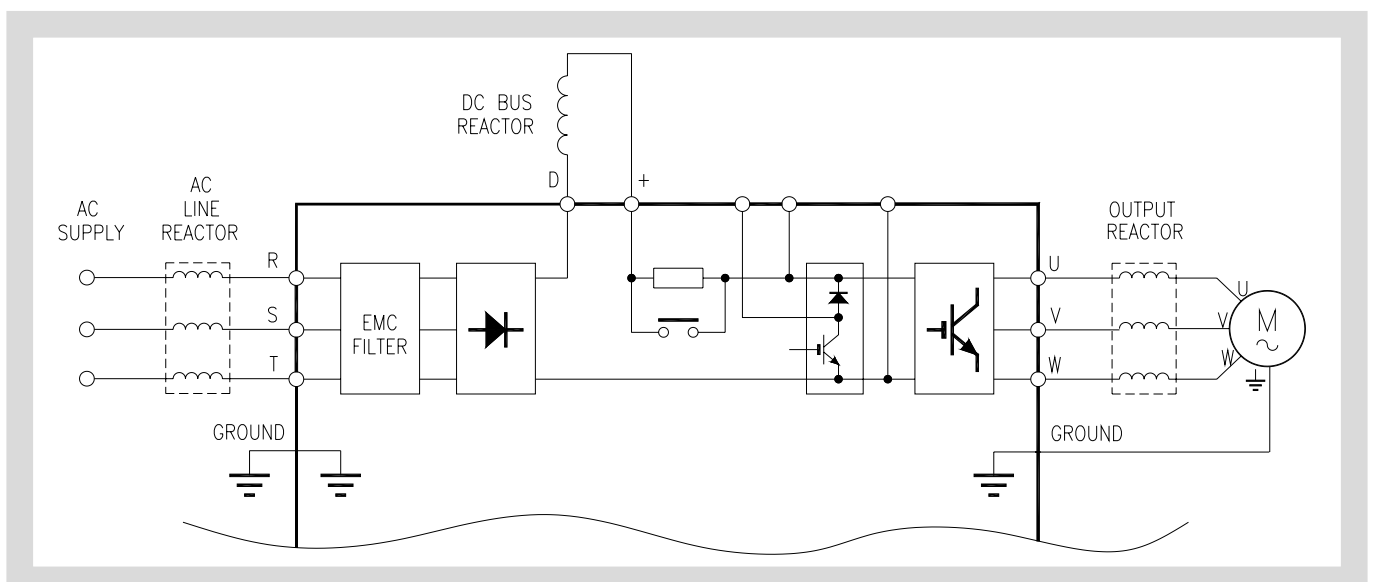

BRAKING UNITS AND RESISTORS



A perfect match of drives, braking units and resistors

SINUS PENTA drives have integrated braking unit up to size S32
Specific external braking units are available from size S41 to S90
Santerno offers a complete set of resistors for each specific application

BRAKING UNITS AND RESISTORS

CONFIGURATIONS



INTEGRATED Braking Unit in SINUS PENTA DRIVE S05-S32

All SINUS PENTA DRIVES up to S32 have an integrated Braking Unit



BU200 for S41-S51 and S60 - S60P

BU200 is the specific external Braking Unit for size S60 (BU200 may be used instead of BU600 also for S41-S51)



BU600 for S41 .. S52 and their parallel configurations and for S60-S60P (BU 600 4T-5T-6T)

BU600 4T-5T-6T is the specific external Braking Unit for size S41-S51 2T-4T, S42-S52 5T-6T and S60-S60P



BU1440 for Modular Inverter S65-S90

BU1440 is the modular Braking Unit for all modular inverters: S65,S70,S75,S80,S90

OPTIONAL BOARDS

*A full range of optional boards for SINUS PENTA
The right solution for every application*

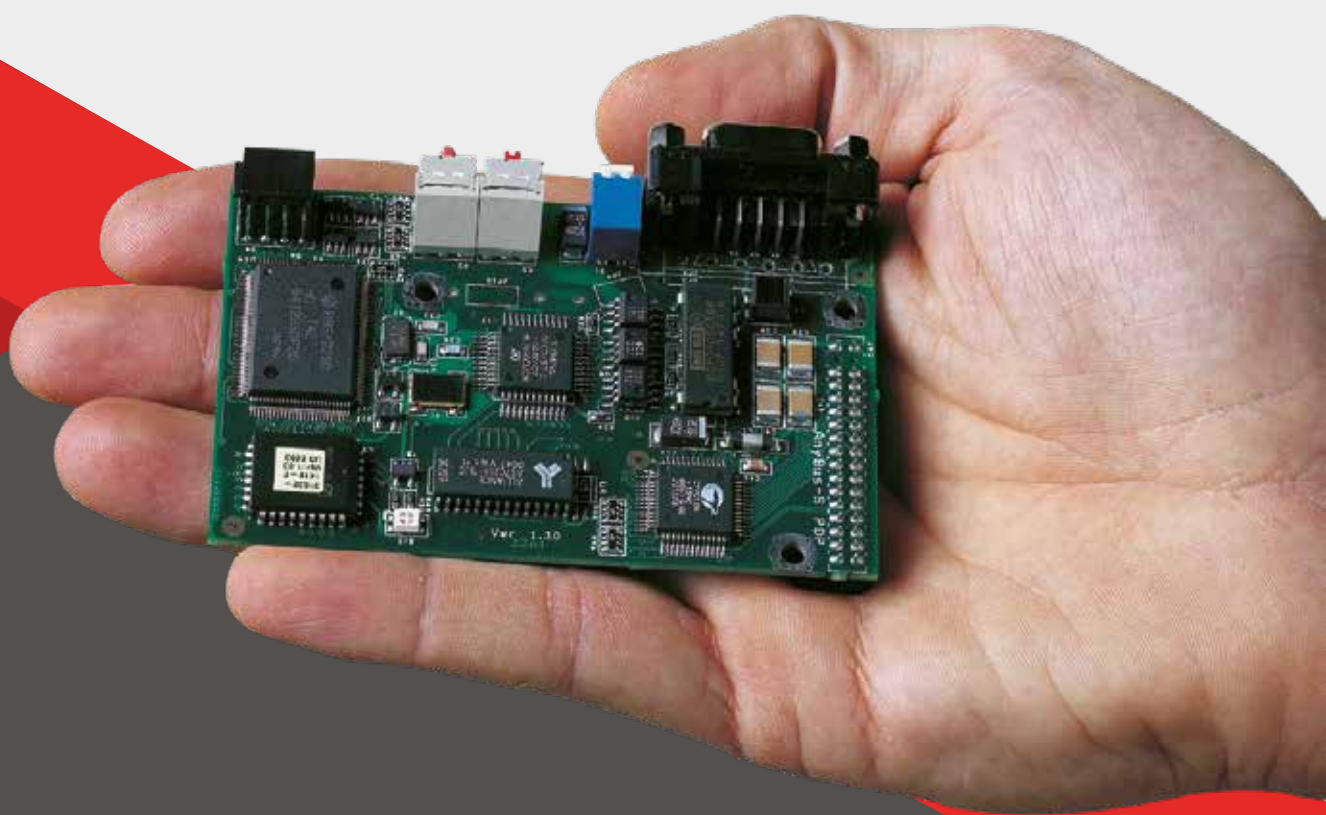

Fieldbus and communication boards for SINUS PENTA

- ES822 Insulated board, RS232 and/or RS485 (this board must be installed on the inverter and it is suggested for ModBus multidrop networks)
- Profinet IRT B40 board (hardware and software kit)
- Ethernet IP B40 board (hardware and software kit)
- EtherCAT B40 board (hardware and software kit)
- Modbus TCP B40 board (hardware and software kit)
- Profibus DP B40 board (hardware and software kit)
- DeviceNet B40 board (hardware and software kit)
- PROFIdrive board (hardware and software kit)
- CANOpen board (hardware and software kit)

Supply boards for SINUS PENTA

- Auxiliary supply board ES914

Speed sensors boards for SINUS PENTA

- ES836 Encoder board
- ES913 LINE DRIVER Encoder board
- ES860 SINcos board
- ES861 Resolver/Encoder board with repeated Encoder + 3 digital Inputs/Outputs
- ES950 BiSS/EnDat Encoder board
- ES966 HIPERFACE Encoder board

I/O expansion boards for SINUS PENTA

- ES847/1 Board 8 Digital Inputs + 6 Transistor Outputs, 4 PT100 inputs up to 260 °C, 1 Analog Voltage input, 1 Analog current input 0-20 mA - for SINUS PENTA plus ADE Energy Counter for Regenerative (RGN) application
- ES870 Board, 8 Digital Inputs + 6 Relay Outputs for SINUS PENTA Regenerative application
- ES988 120 V / 240 V Board, 8 Digital Inputs + 4 Relay Outputs

Datalogger and RTC boards for SINUS PENTA

- Data Logger Bridge Mini board with built-in RTC, Remote Drive connection – connection through GPRS, 4G LTE, optic fiber, ADSL, HDSL, satellite – local Ethernet - RS485

OPTIONAL BOARDS SLOTS ON THE SINUS PENTA CPU BOARD

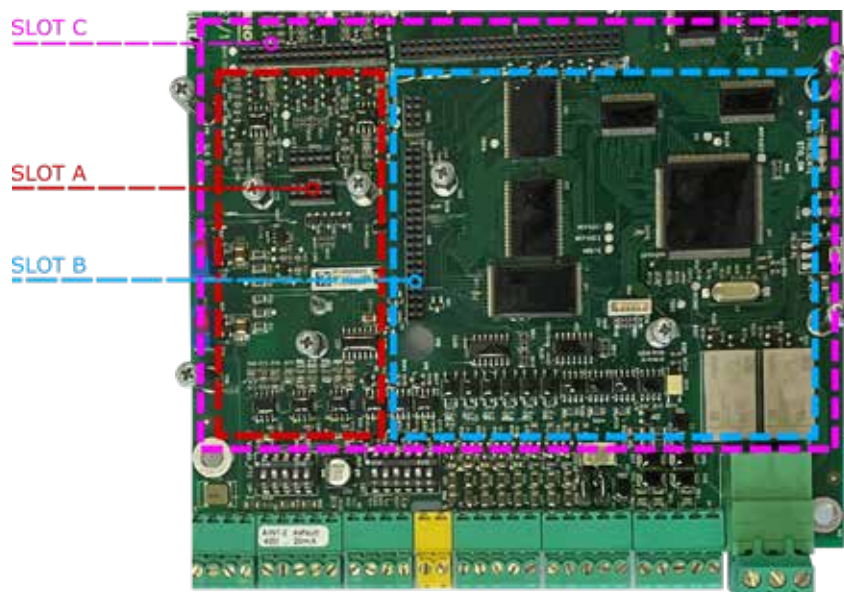

FIELDBUS COMMUNICATION BOARDS



Part number: ZZ0095850
To be installed in SLOT B

ES822 ISOLATED SERIAL BOARD

The isolated serial board RS232/485 controlling SINUS PENTA inverters allows connecting a computer through RS232 interface or allows a multidrop connection of Modbus devices through RS485 interface.



Part number: ZZ4600222
To be installed in SLOT B

PROFINET IRT B40 BOARD

PROFINET (Process Field Network) is a real time network based on Ethernet.

PROFINET is a registered trademark and a patented technology licensed by PROFIBUS & PROFINET International (PI).

The B40 series Profinet IRT communications board allows interfacing between a Sinus Penta drive and an external control unit, using a communications interface based on a real time isochronous Profinet protocol.

Main features:

- Autonegotiation of the baud rate and the type of cable (Auto MDI/MDIX)
- Configuration of the Ethernet parameters from the drive display (please refer to the Programming Guide)
- Ethernet interface galvanically isolated through a transformer
- Two standard RJ-45 connectors (IEEE 802) for Ethernet connection 10/100 (100Base-T, 10Base-T).



Part number: ZZ4600221
To be installed in SLOT B

ETHERNET/IP B40 BOARD

EtherNet/IP is a fieldbus system based on Ethernet that uses Common Industrial Protocol (CIP) for data exchange.

EtherNet/IP and CIP are registered trademarks of ODVA (Open DeviceNet Vendor Association).

The EtherNet/IP communications board allows interfacing between a Sinus Penta drive and an external control unit, using a communications interface based on a EtherNet/IP protocol.

Main features:

- Autonegotiation of the baud rate and the type of cable (Auto MDI/MDIX)
- Configuration of the Ethernet parameters from the drive display (please refer to the Programming Guide)
- Ethernet interface galvanically isolated through a transformer
- Two standard RJ-45 connectors (IEEE 802) for Ethernet connection 10/100 (100Base-T, 10Base-T).

FIELDBUS COMMUNICATION BOARDS



Part number: ZZ4600223
To be installed in SLOT B

ETHERCAT B40 BOARD

EtherCAT (Ethernet for Controller and Automation Technology) is a fieldbus system based on Ethernet that meets the application profile for real-time industrial systems.

EtherCAT is a registered trademark and a patented technology licensed by Beckhoff Automation.

The EtherCAT communications board allows interfacing between a Sinus Penta drive and an external control unit, using a communications interface based on an EtherCAT protocol.

Main features:

- Autonegotiation of the baud rate and the type of cable (Auto MDI/MDIX)
- Configuration of the Ethernet parameters from the drive display (please refer to the Programming Guide)
- Ethernet interface galvanically isolated through a transformer
- Two standard RJ-45 connectors (IEEE 802) for Ethernet connection 10/100 (100Base-T, 10Base-T).



Part number: ZZ4600220
To be installed in SLOT B

MODBUS TCP B40 BOARD

Modbus is an internationally approved asynchronous serial communication protocol designed for commercial and industrial automation applications. The Modbus/TCP communication board allows interfacing between a Sinus Penta drive and an external control unit using a communication interface based on Modbus/TCP Ethernet protocol (IEEE 802) conforming to the Modbus-IDA V1.0 specifications.

Main features:

- Autonegotiation of the baud rate and the type of cable (Auto MDI/MDIX)
- Configuration of the Ethernet parameters from the drive display (please refer to the Programming Guide)
- Ethernet interface galvanically isolated through a transformer
- Two standard RJ-45 connectors (IEEE 802) for Ethernet connection 10/100 (100Base-T, 10Base-T).



Part number: ZZ4600210
To be installed in SLOT B

DEVICENET® B40 BOARD

DeviceNet is a registered trademark ODVA (Open DeviceNet Vendor Association).

The DeviceNet® communications board allows interfacing a drive with an external control unit through a communications interface using a CAN protocol of the DeviceNet type.

Main features:

- CIP Parameters Object Support
- Explicit messages
- Cyclic I/O or polling management
- Automatically detectable baud rate
- Optically isolated CAN interface
- DIP-Switch for line termination insertion

FIELDBUS COMMUNICATION BOARDS

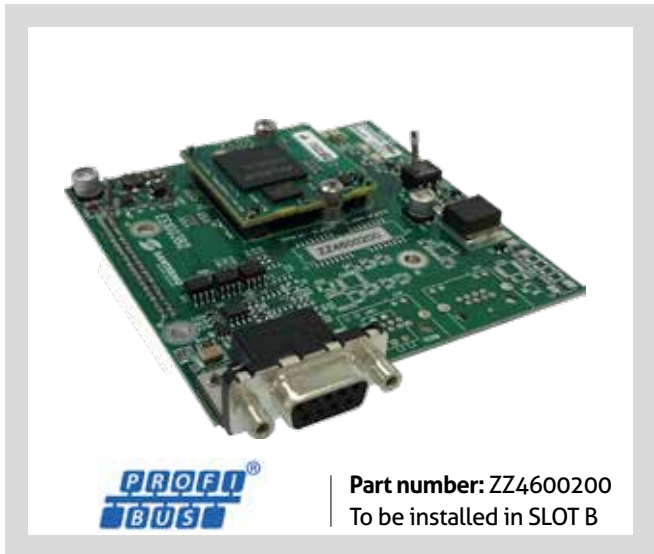

PROFIBUS DP® B40 BOARD

PROFIBUS-DP® is a registered trademark of PROFIBUS & PROFINET International (PI).

The B40 series Profibus® communications board allows interfacing between a Sinus Penta drive and an external control unit, such as a PLC, using a PROFIBUS-DP communications interface.

Main features:

- Type of fieldbus: PROFIBUS-DP EN 50170 (DIN 19245 Part 1) with protocol version 1.10
- Automatic detection of the baud rate ranging from 9600 bits/s to 12 Mbits/s
- Communications device: PROFIBUS bus link, type A or B as mentioned in EN50170
- Type of fieldbus: Master-Slave communications; max. 126 stations in multidrop connection
- Fieldbus connector: female, 9-pin, DSUB connector
- Wire: copper twisted pair (EIA RS485)
- Max length of the bus: 200m @ 1.5Mbits/s (can be longer if repeaters are used)
- Isolation: the bus is galvanically isolated from the electronic devices via a DC/DC converter
- The bus signals (link A and link B) are isolated via optocouplers



PROFIDRIVE® BOARD

PROFIdrive® is a registered trademark of PROFIBUS International. The PROFIdrive® communications board allows interfacing a Sinus Penta drive and an external control unit, such as a PLC, using a PROFIdrive® communications interface.

The PROFIBUS protocol family is specified in the IEC 61158 standard. The communication with a drive is defined in the PROFIdrive Profile – The PROFIBUS Profile for Adjustable Speed Drives. For further information on PROFIBUS, refer to the above mentioned standards



FIELDBUS CANOPEN® BOARD

CANopen® and CiA® are registered trademarks of CAN in Automation e.V. The CANopen communications board allows interfacing a Sinus Penta drive with an external control unit using communications interface operating with a CAN protocol of the CANopen type complying with the CIA DS-301 V3.0 specifications.

The baud rate and the Device Address can be set through the on-board rotary switches. Eight baud rate levels can be set, up to 1Mbit/s.

Main features:

- Unscheduled data exchange support
- Synch & Freeze operating mode
- Possibility of setting Slave Watch-dog timer
- Eight baud rate levels, from 10kbits/s to 1Mbit/s
- Possibility of setting different Device Addresses up to max. 99 nodes
- Optically isolated CAN interface
- CANopen conformity: CIA DS-301 V3.0

AUXILIARY POWER SUPPLY

ES914 AUXILIARY POWER SUPPLY BOARD

ES914 provides insulated power supply to the inverters of the SINUS PENTA series through RS485 connector.

It is supplied on a board-holder support with rear plug connector for DIN rail type OMEGA 35mm.

ES914 board also provides insulation of RS485 signals on the inverter connector. 3-zone insulation is provided: the 24Vdc supply input section, the RS485 section on the Master side and RS485 + 9Vdc supply output on the inverter side are electrically isolated.

ES914 board transmits data in just one direction at a time (halfduplex transmission).

ES914 board is equipped with two indicator LEDs indicating RS485 communication failures. Wiring mismatch (if any) is also detected.



Part number: ZZ0101790
To be installed outside the inverter

ENCODER BOARDS

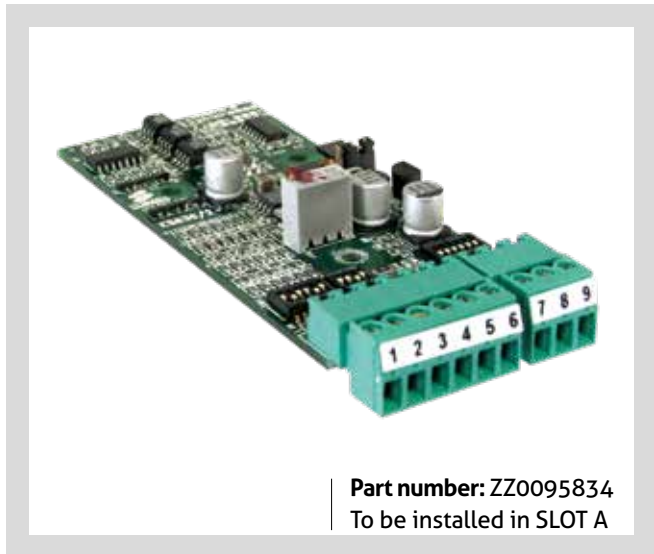

Part number: ZZ0095834
To be installed in SLOT A

ES836 ENCODER BOARD

Board for incremental, bidirectional encoder to be used as a speed feedback for inverters of the SINUS series. It allows the acquisition of encoders with power supply ranging from 5 to 15VDC (adjustable output voltage) with complementary outputs (Line Driver, Push-Pull, TTL outputs). It can also be connected to 24DC encoders with both complementary and single-ended push-pull or PNP/NPN outputs.

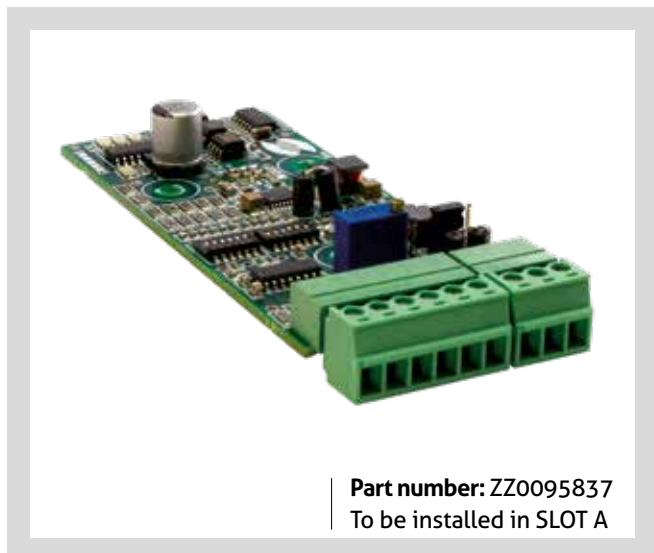

Part number: ZZ0095837
To be installed in SLOT A

ES913 LINE DRIVER ENCODER BOARD

Board for incremental, bidirectional encoder to be used as a speed feedback for the inverters of the SINUS series. It allows the acquisition of encoders with power supply ranging from 5 to 24VDC (adjustable output voltage) with line driver outputs. The encoder board is to be installed into SLOT A.

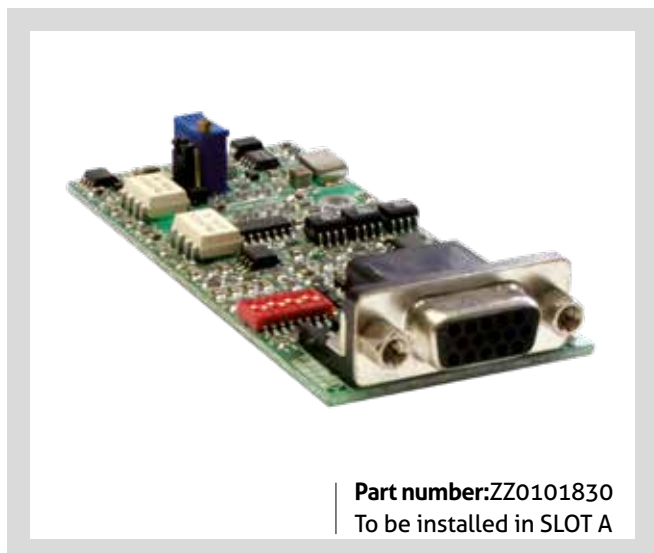

Part number: ZZ0101830
To be installed in SLOT A

ES860 SIN/COS ENCODER BOARD

Board for encoders provided with 1Volt peak-to-peak analog outputs. To be used to provide speed feedback and/or position feedback for the inverters of the SINUS PENTA series.

Two acquisition modes as follows:

- Three-channel mode: increments low speed resolution and is suitable for slow rotation speed actuators requiring very accurate measurement of speed and position.
- Five-channel mode: detects the absolute mechanical position as soon as the inverter is first started up.

Main features:

- Two channels acquired via zero crossing and bidirectional digital counter with quadrature direction
- Zero index control for accurate alignment
- Two channels acquired in analog mode for absolute angle detection (12-bit resolution).

ES861 RESOLVER AND INCREMENTAL ENCODER BOARD

Board for resolver signals, it converts them into 12-bit digital signals that can be used as speed and/or position feedback for the inverters of the SINUS PENTA series.

It also generates the sinusoidal signal for the resolver excitation and features dedicated logics for the acquisition of differential signals sent from incremental encoders and for the control of optoisolated digital inputs and outputs.

Main features:

- Resolver to Digital (RtD) conversion allowing selecting motor position readout or speed readout.
- Configurable frequency and gain of the excitation signal and the reading signals from the Resolver.
- Incremental encoder output generated from RtD to line driver (TIA/EIA-422) at 1024 pls/rev, repeated also to the internal bus of the inverter.



Part number: ZZ0101860
To be installed in SLOT C

ES950 BiSS/EnDat ENCODER BOARD

The encoder board allows connecting absolute encoders with digital serial interface using mutually exclusive BiSS and EnDat 2.2 protocols and allows using them to provide speed feedback and/or position feedback for the inverters of the Sinus PENTA series.

The absolute measurement allows detecting the exact position of the motor as soon as the inverter is started, thus avoiding demanding alignment checks.

The ES950 board also features control logics for additional functions, such as the acquisition of differential incremental signals from external encoders and the control of optoisolated digital inputs/outputs.



Part number: ZZ0101890
(ES950 BiSS)
To be installed in SLOT C



Part number: ZZ0101880
(ES950 EnDat)
To be installed in SLOT C

ES966 Hiperface ENCODER BOARD

HIPERFACE® is a registered trademark by SICK STEGMANN.

The Hiperface Encoder Board allows users to connect single-turn or multi-turn encoders that have the HIPERFACE® interface to provide speed feedback and/or position feedback for the inverters of the Sinus PENTA series.

HIPERFACE® interface have been designed as Motor Feedback systems for drive technology. This results in compact design.



Part number: ZZ0101895
To be installed in SLOT C

DATA LOGGER BOARDS

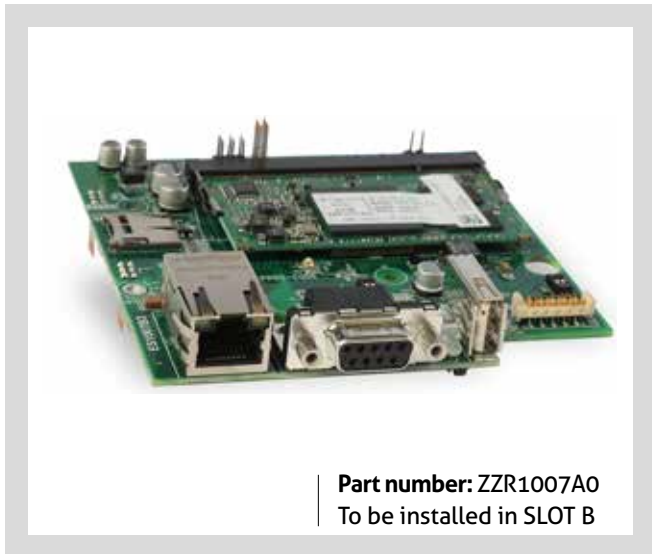

Part number: ZZR1007A0
To be installed in SLOT B

BRIDGE MINI EMBEDDED ES1007 BOARD

The Bridge Mini Embedded Datalogger is an optional board that allows to acquire the operating variables of a plant and interface with supervisor devices (such as PPC and SCADA), even remotely, with various connection modes for recording data and monitoring the devices connected to the plant.

Main features:

- 512 Mb of data;
- RS485 Interface with Modbus-RTU protocol;
- Ethernet Interface with Modbus-TCP protocol;
- Interface for connection through GPRS, 4G LTE, optic fiber, ADSL, HDSL, satellite, WiMAX.
- Real Time Clock (RTC) that saves the date and time even when the inverter is not supplied. The inverter firmware can use the data related to date and time to manage the various scheduled events.
- COM0 of the inverter occupied by the Bridge Mini board



Part number: ZZ4600600
To be installed on DIN guide

BRIDGE MINI STANDALONE BOARD

The Datalogger Bridge Mini Standalone board shall be connected outside the inverter.

With this solution the COM0 of the inverter is not inhibited and can be used.

I/O EXPANSION BOARDS

ES847 I/O EXPANSION BOARD

ES847 Board allows implementing an additional I/O set for any product of the PENTA series

Additional functionality includes:

- N.1 "fast" sampling analog inputs, 12-bit, $\pm 10V$ f.s.;
- N.2 "fast" sampling analog inputs, 12-bit, for AC current measure via CTs or for 0-20mA sensor measures; resolution: 11 bits;
- N.1 "fast" sampling analog input for $\pm 160mA$ f.s. sensor measures; resolution: 12 bits (Energy Counter option);
- N.4 "slow" sampling inputs, 12-bit, configurable as 0-10V f.s., 0-20 mA f.s., 0-100 mV f.s., temperature acquisition via two-wire thermistor PT100;
- N.2 "slow" sampling analog inputs, 12-bit, 0-10V f.s.;
- N.3 voltage inputs for ADE (Energy Counter option);
- N.8 current inputs for ADE (Energy Counter option);
- N.8 PNP, 24V multifunction digital inputs;
- N.6 multifunction digital outputs



Part number: ZZ0101814
To be installed in SLOT C

ES870 RELAY I/O EXPANSION BOARD

ES870 board is an expansion board for the digital I/Os of all the products of the SINUS PENTA series.

ES870 board includes:

- N.8 24V multifunction digital inputs, type PNP. Three inputs are "fast propagation" inputs that can be used also for PUSH-PULL 24V encoder acquisition;
- N.6 multifunction relay outputs



Part number: ZZ0101840
To be installed in SLOT C

ES988 120V/240V I/O EXPANSION BOARD

ES988 board is an expansion board for the digital I/Os of all the products of the SINUS PENTA series.

ES988 board includes:

- N.8 multifunction digital inputs 120/240V
- N.4 multifunction relay outputs 120/240V

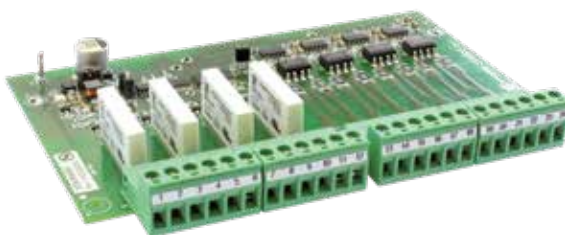

Part number: ZZR0988B0 (120/240Vrms $\pm 10\%$)
To be installed in SLOT C

ASA 4.0 Soft Starter



ASA 4.0 BASIC: Soft Starter for in-line connections

***ASA 4.0 ADVANCED: Soft Starter for Advanced Motor Control
In-line or Inside-delta Connections***

TECHNICAL FEATURES AND HIGHLIGHTS

- A product designed to meet the needs of our customers in a simple and intuitive way: better display functions, advanced connectivity and easy access to data.
- Multilanguage graphic display with quick configuration menu for the most common applications.
- Integrated bypass contactor.
- The integrated USB port allows storing performance data, updating the firmware and configuring the device easily and quickly, thus reducing to a minimum the inactive periods of the plant.
- The integrated planning and automation functionality enables programming and executing custom operations to meet different plant requirements while reducing manual control to a minimum and ensuring continuous operation.
- Event log.

EASY INTEGRATION

The optional Smart Cards cards provide the specific features required for different application needs, simplifying the system design, installation and commissioning. Smart Cards can be easily inserted into the appropriate slot on the ASA 4.0 product. The wide choice of optional field bus boards facilitates integration into systems, ensuring better monitoring and process control.

CURRENT AND OVERLOAD RANGE

24 A to 580 A (nominal) (ASA 4.0 BASIC)

24 A to 1250 A (nominal) (ASA 4.0 ADVANCED)

Overload up to 600% of the rated current

VOLTAGE RANGE

3 x 200 ÷ 525 Vac o 3 x 380 ÷ 600 Vac (ASA 4.0 BASIC)

3 x 200 ÷ 525 Vac o 3 x 380 ÷ 690 Vac (ASA 4.0 ADVANCED)

ENERGY SAVING

All models have an internal bypass to reduce the power consumption of the application and operation of the device. The most efficient solution for fixed speed applications.

A Soft Starter with bypass provides maximum energy savings when used in combination with an IE3 or IE4 motor.

OPTIMIZED INSTALLATION AND MAINTENANCE

Thanks to their compact dimensions, the new ASA 4.0 soft starters take up less space inside the panels and in the wall installations, saving considerable costs. The entire range is made with two sizes up to 30% more compact than other devices in this category. A unique feature of ASA 4.0 is the management of QR codes generated by the display. Scanning QR code from your smartphone or tablet allows you to quickly access information about your device or any alarms.

FUNCTIONS	ASA 4.0 BASIC	ASA 4.0 ADVANCED
Motor Configurations	1	2
Constant current and current ramp at start up	✓	✓
Start/stop adaptive control	✓	✓
Kickstart		✓
Coast to stop and TVR	✓	✓
DC Brake		✓
Soft brake		✓
Jog (forward and reverse)		✓
Inside-delta connection control (6-wire)		✓
Soft trip		✓
SCR Fail PowerThrough Operation		✓
Automatic Start/Stop programming (RTC)		✓
Number of controlled phases	2	3

OPTIONS

PUMPING SMART CARD

The Pumping Smart Card allows direct connection of the plant sensors to the soft starter.

The card is provided with:

- n. 3 digital revenue
- No. 3 entries 4-20
- No. 1 RTD entry
- n. 1 USB-B port
- Remote keyboard connector

REMOTE KEYBOARD

The keyboard can be mounted at a maximum distance of 3 meters from the Soft Starter for the purpose of monitoring and control. Expansion cards are provided with the dedicated connector for the connection of the Remote Keyboard

COMMUNICATION MODULES

- Modbus RTU
- Profibus
- DeviceNet
- Modbus TCP
- ProfiNet
- Ethernet IP

SAFEGUARD KIT

The finger savers are inserted on the terminals of the Soft Starter to prevent accidental contact with the terminals under voltage

EXPANSION BOARDS

Expansion cards provide advanced features or additional I/O. The ASA 4.0 product can only accommodate one expansion card

PRODUCT SELECTION CHART

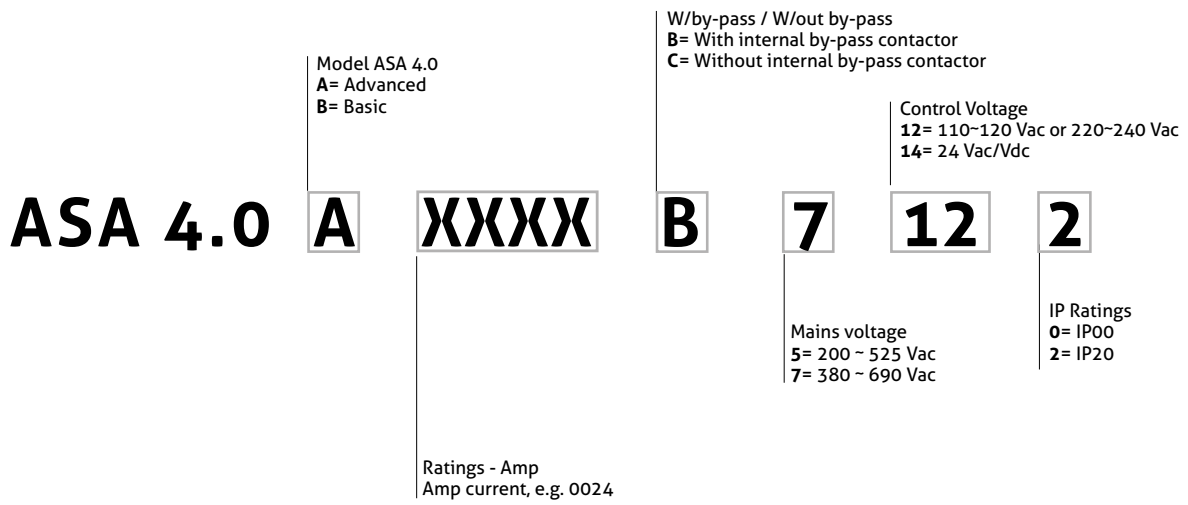

INSIDE DELTA (6-WIRES CONNECTION) WITH ASA 4.0 ADVANCED ONLY

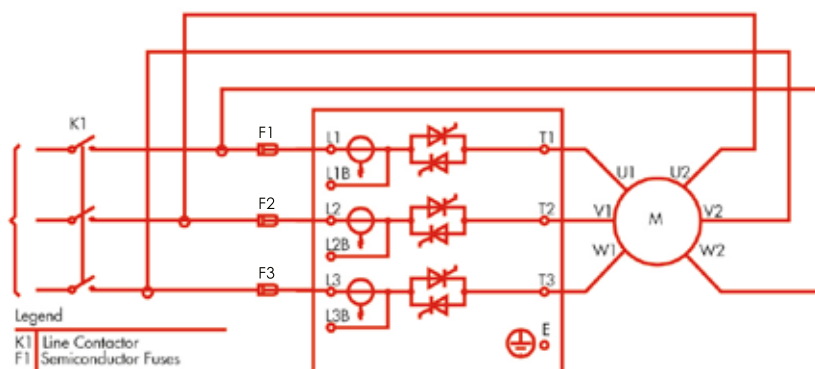

OVERLOAD VALUE CALCULATION: IST

Example: 45 kW, 400/690 Vac 4-poles motor for bore pump, TL= Max starting torque requested by load = 98 Nm.

Motor type	Pn		Nn	Tn	In a 400V	cosfi	η	Is	Ts	Tmax	TL	Weight (kg)
	kW	CV	Giri/min	Nm	(A)	F.P.	%	In	Tn	Tn	Nm	
MA 225 M 4	45	60	1475	291,5	80	0,88	92,3	7,2	2,2	2,3	98	309

$$IST = \sqrt{\frac{T_L}{T_s} \times \frac{I_s}{I_n}} = \sqrt{\frac{98}{2,2 \times 291,5}} \times 7,2 = 2,8$$

Overload choice

Applications	Overload (IST)			
	3	3,5	4	4,5
Agitator			•	
Atomizer			•	
Ball mill				•
Bandsaw				•
Bore pumb	•			
Bottle washer	•			
Centrifugal compressor		•		
Centrifugal damped fan		•		
Centrifugal pumps		•		
Centrifuge				•
Chipper				•
Circulator saw		•		
Conveyor belt				•
Conveyor roller		•		
Conveyor screw			•	
Crusher cone		•		
Crusher jaw				•
Crusher rotary		•		
Crusher vertical impact		•		
Damped axial fan		•		
Debarker		•		
Dryer				•
Dust collector		•		
Edger		•		
Fan high pressure				•

Applications	Overload (IST)			
	3	3,5	4	4,5
Grimmer			•	
Hammer mill				•
Hydraulic power pack			•	
Loaded pistol compressor				•
Mill				•
Mixer				•
Palletiser				•
Planers		•		
Positive displacement pump			•	
Press		•		
Pulper				•
Roller mill				•
Rotary table			•	
Sander			•	
Screw compressor, loaded			•	
Screw compressor, unloaded		•		
Separator				•
Shredder				•
Slicer	•			
Slurry pumps				•
Tumbler			•	
Undamped axial fan				•
Undamped centrifugal fan				•
Unloaded piston compressor			•	

The above tables are intended as a guide only. Individual machine and motor characteristics will determine the actual start current requirements. For accurate designing see the example.

ASA 4.0 BASIC – CURRENT RATINGS

Model	Starts per hour	300%, 10 s	350%, 15 s	400%, 10 s	400%, 20 s	500%, 5 s	Starts per hour	300%, 10s	350%, 15s	400%, 10s	400%, 20s	500%, 5 s
	N.	Amp	Amp	Amp	Amp	Amp	N.	Amp	Amp	Amp	Amp	Amp
	Rated Values w/by-pass In-line Connection						Rated Values w/by-pass Inside Delta connection					
ASA4.0-B 0024B	10	24	20	19	16	17	-	-	-	-	-	-
ASA4.0-B 0042B	10	42	34	34	27	32	-	-	-	-	-	-
ASA4.0-B 0052B	10	52	42	39	35	34	-	-	-	-	-	-
ASA4.0-B 0064B	6	64	63	60	51	54	-	-	-	-	-	-
ASA4.0-B 0069B	6	69	69	69	62	65	-	-	-	-	-	-
ASA4.0-B 0105B	6	105	86	84	69	77	-	-	-	-	-	-
ASA4.0-B 0115B	6	115	108	105	86	95	-	-	-	-	-	-
ASA4.0-B 0135B	6	135	129	126	103	115	-	-	-	-	-	-
ASA4.0-B 0184B	6	184	144	139	116	127	-	-	-	-	-	-
ASA4.0-B 0200B	6	200	171	165	138	150	-	-	-	-	-	-
ASA4.0-B 0229B	6	229	194	187	157	170	-	-	-	-	-	-
ASA4.0-B 0250B	6	250	244	230	200	202	-	-	-	-	-	-
ASA4.0-B 0352B	6	352	287	277	234	258	-	-	-	-	-	-
ASA4.0-B 0397B	6	397	323	311	263	289	-	-	-	-	-	-
ASA4.0-B 0410B	6	410	410	410	380	400	-	-	-	-	-	-
ASA4.0-B 0550B	6	550	527	506	427	464	-	-	-	-	-	-
ASA4.0-B 0580B	6	580	579	555	470	508	-	-	-	-	-	-

Note: Current ratings are for ≤1000 m altitude and ≤40 °C environmental temperature.

ASA 4.0 ADVANCED – CURRENT RATINGS

Model	Starts per hour	300%, 10 s	350%, 15 s	400%, 10 s	400%, 20 s	500%, 5 s	Starts per hour	300%, 10s	350%, 15s	400%, 10s	400%, 20s	500%, 5s
	N.	Amp	Amp	Amp	Amp	Amp	N.	Amp	Amp	Amp	Amp	Amp
	Rated Values with by-pass In-line Connection						Rated Values with by-pass Inside Delta connection					
ASA4.0-A 0024B	10	24	20	19	16	16	10	36	30	29	24	24
ASA4.0-A 0042B	10	42	34	34	27	31	10	63	51	51	41	47
ASA4.0-A 0052B	10	52	41	39	34	34	10	78	62	59	51	51
ASA4.0-A 0064B	6	64	62	60	50	53	6	96	93	90	75	80
ASA4.0-A 0069B	6	69	69	69	62	64	6	104	104	104	93	96
ASA4.0-A 0105B	6	105	86	84	68	76	6	158	129	126	102	114
ASA4.0-A 0115B	6	115	107	104	86	95	6	173	161	156	129	143
ASA4.0-A 0135B	6	135	129	126	103	115	6	203	194	189	155	173
ASA4.0-A 0184B	6	184	143	139	115	127	6	276	215	209	173	191
ASA4.0-A 0200B	6	200	170	165	138	150	6	300	255	248	207	225
ASA4.0-A 0229B	6	229	194	187	157	170	6	344	291	281	236	255
ASA4.0-A 0250B	6	250	244	230	200	202	6	375	366	345	300	303
ASA4.0-A 0352B	6	352	285	277	234	257	6	528	428	415	351	386
ASA4.0-A 0397B	6	397	322	311	262	288	6	596	484	466	393	433
ASA4.0-A 0410B	6	410	410	410	379	400	6	615	615	615	568	600
ASA4.0-A 0550B	6	550	526	505	427	462	6	825	789	758	640	694
ASA4.0-A 0580B	6	580	570	554	469	507	6	870	868	832	704	760
ASA4.0-A 0835B	6	835	654	630	535	592	6	1253	981	945	803	888
ASA4.0-A 0940B	6	940	736	708	603	663	6	1410	1104	1062	905	995
ASA4.0-A 1070B	6	1070	950	905	785	834	6	1605	1425	1358	1178	1251
ASA4.0-A 1230B	6	1230	1154	1090	959	989	6	1845	1731	1635	1439	1484
ASA4.0-A 1250B	6	1250	1250	1250	1155	1250	6	1875	1875	1875	1733	1875
ASA4.0-A 0735C	6	835	732	716	593	695	6	1253	1098	1070	890	1043
ASA4.0-A 0830C	6	940	822	803	667	776	6	1410	1233	1205	1001	1164
ASA4.0-A 1025C	6	1210	1067	1033	874	1170	6	1815	1601	1550	1311	1473
ASA4.0-A 1170C	6	1430	1307	1252	1076	1170	6	2145	1961	1878	1614	1755
ASA4.0-A 1220C	6	1620	1620	1616	1309	1620	6	2430	2430	2424	1964	2430
	Rated values without by-pass Inside Delta Connection						Rated values without by-pass Inside Delta Connection					
ASA4.0-A 0735C	6	735	590	572	492	542	6	1103	885	858	738	813
ASA4.0-A 0830C	6	830	667	645	557	609	6	1245	1001	968	836	914
ASA4.0-A 1025C	6	1025	839	805	710	751	6	1538	1259	1208	1065	1127
ASA4.0-A 1170C	6	1170	979	934	838	862	6	1755	1469	1401	1257	1293
ASA4.0-A 1220C	6	1220	1134	1109	964	1075	6	1830	1701	1664	1446	1613

Note: Current ratings are for ≤1000 m altitude and ≤40 °C environmental temperature.

ASA 4.0 BASIC AND ADVANCED – DIMENSIONS AND WEIGHT

Model	Size	Dimensions LxAxP mm	Weight kg
ASA4.0-A 0024B ASA4.0-B 0024B	G1	152x336x233	4.8
ASA4.0-A 0042B ASA4.0-B 0042B	G1	152x336x233	4.8
ASA4.0-A 0052B ASA4.0-B 0052B	G1	152x336x233	4.9
ASA4.0-A 0064B ASA4.0-B 0064B	G1	152x336x233	4.9
ASA4.0-A 0069B ASA4.0-B 0069B	G1	152x336x233	4.9
ASA4.0-A 0105B ASA4.0-B 0105B	G1	152x336x233	5.5
ASA4.0-A 0115B ASA4.0-B 0115B	G1	152x336x233	5.5
ASA4.0-A 0135B ASA4.0-B 0135B	G1	152x336x233	5.5
ASA4.0-A 0184B ASA4.0-B 0184B	G2	216x495x245	12.7
ASA4.0-A 0200B ASA4.0-B 0200B	G2	216x495x245	12.7
ASA4.0-A 0229B ASA4.0-B 0229B	G2	216x495x245	12.7
ASA4.0-A 0250B ASA4.0-B 0250B	G2	216x495x245	12.7
ASA4.0-A 0352B ASA4.0-B 0352B	G2	216x523x245	15.5
ASA4.0-A 0397B ASA4.0-B 0397B	G2	216x523x245	15.5
ASA4.0-A 0410B ASA4.0-B 0410B	G2	216x523x245	15.5
ASA4.0-A 0550B ASA4.0-B 0550B	G2	216x523x245	19.0
ASA4.0-A 0580B ASA4.0-B 0580B	G2	216x523x245	19.0
ASA4.0-A 0835B	G3	447x618x310	51.0
ASA4.0-A 0940B	G3	447x618x310	51.0
ASA4.0-A 1070B	G3	447x618x310	62.0
ASA4.0-A 1230B	G3	447x618x310	63.0
ASA4.0-A 1250B	G3	447x618x310	65.0
ASA4.0-A 0735C	G3	447x618x310	47.0
ASA4.0-A 0830C	G3	447x618x310	47.0
ASA4.0-A 1025C	G3	447x618x310	58.0
ASA4.0-A 1170C	G3	447x618x310	59.0
ASA4.0-A 1220C	G3	447x618x310	61.0

ASAMV Soft starter



Soft start/stop static starters Medium Voltage

- Power supply voltage range, 2300 Vac - 13800 Vac, rated current 100 to 1000 A
- Input frequency 50 - 60 Hz
- Full compatibility with the "REMOTE DRIVE" software for remote control

TECHNICAL FEATURES & HIGHLIGHTS

- Power supply from 2300 Vac to 13800 Vac rated current 100 to 1000 A
- 3 types of motor starting (Constant Current, Current Ramp, Torque Control)
- Stopping (Soft Stop, Pump control profiles, Auto Stop)
- Allowed overload to 600% of the nominal current
- CABINET MODEL IP54 protection degree Class A EMC
- Operating temperature from 0 to +50 °C (option from -20 to +50 °C)
- Protection: Under/ Overvoltage, Supply Frequency, Phase Sequence, Shorted SCR, Motor Overload (Thermal Model), Instantaneous Overcurrent, Undercurrent, Current Imbalance,

- Excess Start Time, Power Circuit, Auxiliary Trip
- Interface: 5 Remote Control Inputs (3 x fixed, 2 x programmable), 6 Relay Outputs (3 fixed, 3 x programmable), Analog Output (1 x programmable), Serial Output (1 x RS485 Modbus-RTU)
- Human Interface: 20-character, 2-line LCD display, Start-Stop-Reset-Local/Remote keys, Starter Status LEDs, Event Log (99 positions, date and time stamped), Trip Log (60 positions, date and time stamped), Counters (starts, hours-run, kWh), Metering (current, voltage, power factor, kWh), User Programmable Metering Screen, Multi-Level Password Protection

OPTIONS

- RTD Interface
- PT100 interface
- Profibus Interface
- DeviceNet Interface
- Synchronous Motor Control
- Remote Drive PC software
- Remote Operator
- Control supply transformer
- Ground fault protection

SOFT-STARTER CONFIGURATION

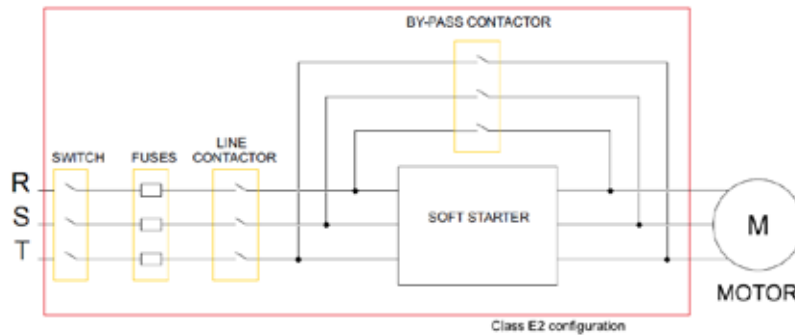

PRODUCT SELECTION CHART

ASAMV CABINET 0200 06 E2

Supply Voltage
02 = 2300 VAC 50/60 Hz
03 = 3300 VAC 50/60 Hz
04 = 4160 VAC 50/60 Hz
6000 = 6000 VAC 50/60 Hz
06 = 6600 VAC 50/60 Hz
07 = 7200 VAC 50/60 Hz
11 = 11000 VAC 50/60 Hz
13 = 13800 VAC 50/60 Hz

- Current rating :
- 0100 = 100 A, 500% 60 sec, 600% 30 sec - E2
 - 0200 = 200 A, 500% 60 sec, 600% 30 sec - E2
 - 0300 = 300 A, 500% 60 sec, 600% 30 sec - E2
 - 0400 = 400 A, 500% 60 sec, 600% 30 sec - E2
 - 0600 = 600/630 A*, 500% 60 sec, 600% 30 sec - E2
 - 0800 = 800 A, 500% 60 sec, 600% 30 sec - E2
 - 1000 = 1000 A, 500% 60 sec, 600% 30 sec - E2

(*) 600 A for Supply voltage 06/07/11/13
 630 A for power supply voltage 02/03/04

E2 = IP54 Enclosure, by-pass contactor, Line contactor, Fuses, Switch-gear

DIMENSIONS AND WEIGHT

Model ASAMV-CABINET	IP54			Kg
	H (mm)	L (mm)	D (mm)	
200-02-E2	2350	914	762	591
400-02-E2	2350	914	762	591
600-02-E2	2350	1829	762	1182
200-03-E2	2350	914	762	591
400-03-E2	2350	914	762	591
600-03-E2	2350	1829	762	1182
200-04-E2	2350	914	762	591
400-04-E2	2350	914	762	591
600-04-E2	2350	1829	762	1182
200-06-E2	2350	1067	762	1182
400-06-E2	2350	1067	762	1182
600-06-E2	2350	2972	762	1818
200-07-E2	2350	1829	762	1364
400-07-E2	2350	1829	762	1364
600-07-E2	2350	2972	762	1818
100-11-E2	2413	3200	1118	2136
200-11-E2	2413	3200	1118	2136
400-11-E2	2413	3200	1118	2136
600-11-E2	2413	3200	1118	2136
100-13-E2	2413	3200	1118	2136
200-13-E2	2413	3200	1118	2136
400-13-E2	2413	3200	1118	2136
600-13-E2	2413	3048	2032	2727

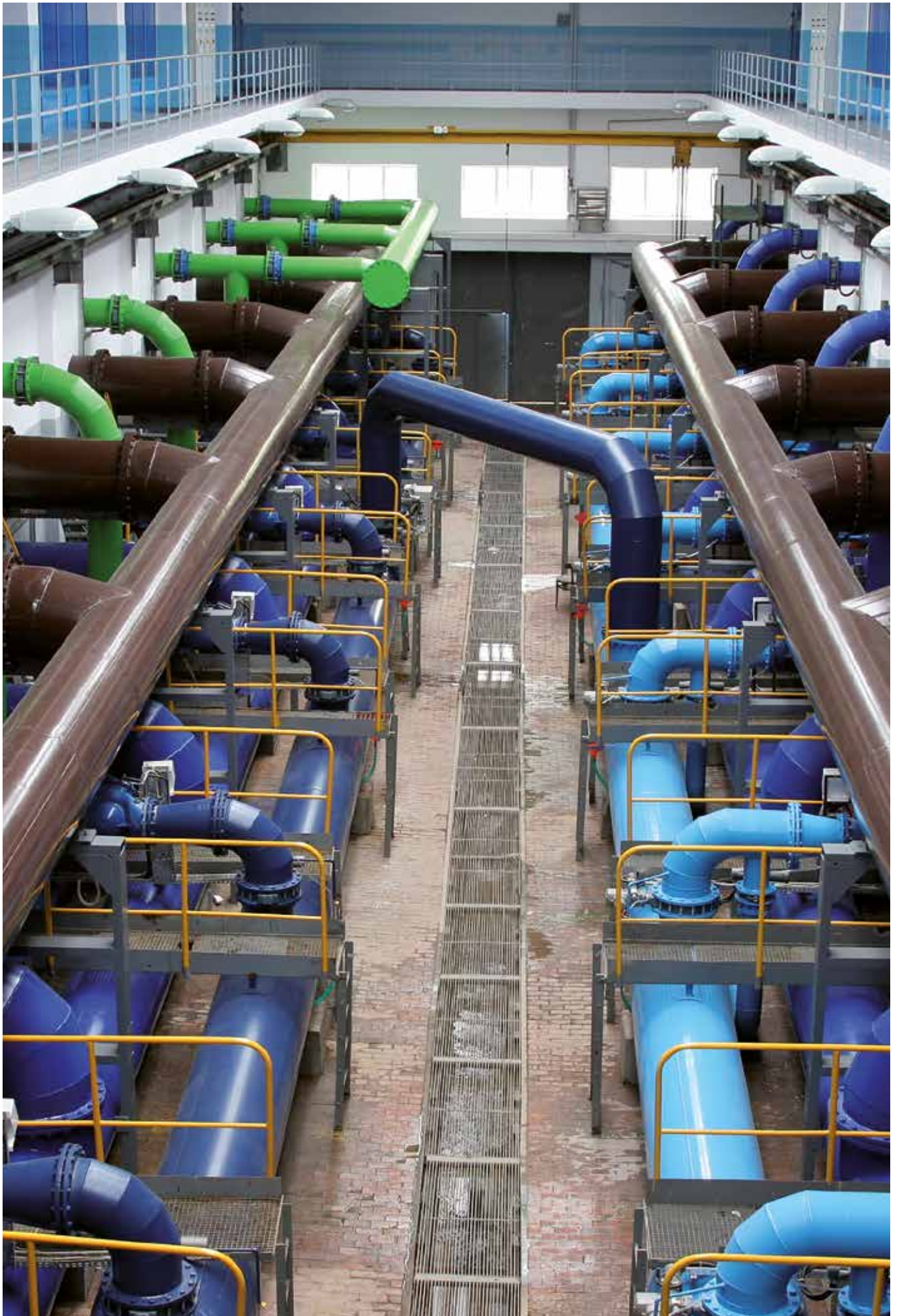

DCREG2-DCREG4



**3 YEARS
WARRANTY**

***AC/DC digital converters
two quadrant DCREG2
four quadrant DCREG4***

- Power range 10 A - 4500 A (2.4 kW - 3200 kW)
- Wide power supply voltage range, 200 Vac - 690 Vac
- Input frequency 50 - 60 Hz
- Full compatibility with the REMOTE DRIVE software for remote control

TECHNICAL FEATURES AND HIGHLIGHTS

- Self-calibration of current and speed (reduced possibility of error and installation time)
- Self-calibration of field (Reduces possibility of error and installation time)
- Internal field converter (for operation at constant torque or power)
- Field economy (reduces the field current when the motor is stopped)
- Field boost (increases torque on motor start)
- Predictive control (increases the dynamic response of the motor)
- Integrated multimeter
- Speed multiramps
- "S" ramps
- Double speed loop regulator
- Feedback from tachometric dynamo, from encoder and armature
- Automatic switching of the feedback in armature in the event of breakdown of tachometer/encoder (higher safety operation)
- Control of the current limit in steps or hyperbolic
- 7 levels of speed
- JOG commands
- Auto-reset alarms
- Integrated digital potentiometer
- Timer on digital outputs
- Local control from keyboard
- Insensitivity to phase sequence (easier connection)
- Independent supplies to control and power
- 8 programmable inputs
- 4 programmable analog inputs 0-±10 Vdc, 0(4)-20 mA
- Double encoder input
- 5 programmable relay outputs
- Auxiliary 24 Vdc, ±10 Vdc, 5 Vdc
- 1 analog speed output ±10 Vdc
- 1 analog current output ±10 Vdc
- 2 programmable analog outputs 0-±10 Vdc, 0(4)-20 mA
- EMC compliant with EN 61800-3 2nd ed.

OPTIONS

- "Remote Drive" software
- Keypad
- Remote keyboard operation kit (5 metres)
- RS232/485 interface
- MODBUS RTU 115.2kbps
- Profibus DP 12Mbps - CanBus - Device Net etc.
- IP 20 protection degree kit
- Input chokes
- Kit for heatsink segregation
- Fast fuses
- CU400 Clamping unit for electromagnets
- DC chokes

PRODUCT SELECTION CHART

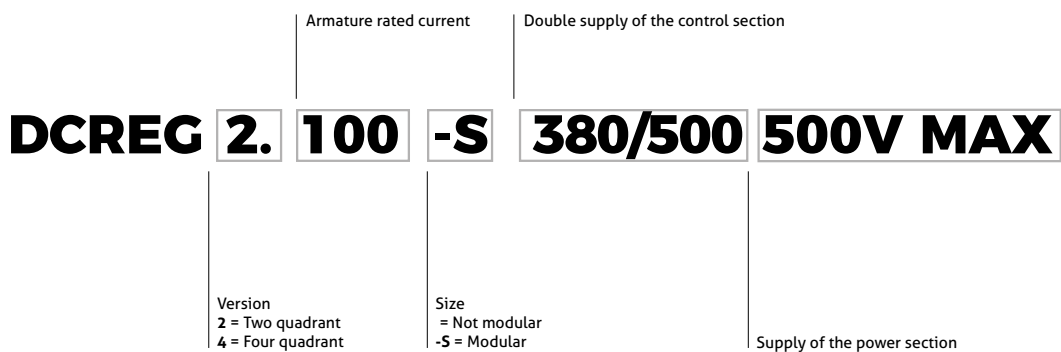

DCREG2



Size 1

Model	Input	DCREG2.10	DCREG2.20	DCREG2.40	DCREG2.70
*Armature rated current		10A	20A	40A	70A
Overload		150%	150%	150%	150%
Armature output Voltage	440 Vac	530 Vdc max	530 Vdc max	530 Vdc max	530 Vdc max
	500 Vac	600 Vdc max	600 Vdc max	600 Vdc max	600 Vdc max
	600 Vac	720 Vdc max	720 Vdc max	720 Vdc max	720 Vdc max
	690 Vac	800 Vdc max	800 Vdc max	800 Vdc max	800 Vdc max
Field rated current		5A	5A	5A	5A
Field output voltage	500 Vac	425 Vdc max	425 Vdc max	425 Vdc max	425 Vdc max
AC fast fuses		35-40A 00T/80	35-40A 00T/80	35-40A 00T/80	63A 00T/80
DC fast fuses		35-40A 00T/80	35-40A 00T/80	50A 00T/80	100A 00T/80
*Dimensions (WxDxH) mm		214x265x440	214x265x440	214x265x440	214x265x440
*Weight (kg)		13	13	13	14

Size 1

Model	Input	DCREG2.100	DCREG2.150	DCREG2.180	DCREG2.250	DCREG2.350
*Armature rated current		100A	150A	180A	250A	350A
Overload		150%	150%	150%	150%	150%
Armature output Voltage	440 Vac	530 Vdc max	530 Vdc max	530 Vdc max	530 Vdc max	530 Vdc max
	500 Vac	600 Vdc max	600 Vdc max	600 Vdc max	600 Vdc max	600 Vdc max
	600 Vac	720 Vdc max	720 Vdc max	720 Vdc max	720 Vdc max	720 Vdc max
	690 Vac	800 Vdc max	800 Vdc max	800 Vdc max	800 Vdc max	800 Vdc max
Field rated current		5A	15A	15A	15A	15A
Field output voltage	500 Vac	425 Vdc max	425 Vdc max	425 Vdc max	425 Vdc max	425 Vdc max
AC fast fuses		100A 00T/80	160A 00T/80	160A 00T/80	250A 00T/80	315A 00T/80
DC fast fuses		125A 00T/80	200A 00T/80	250A 00T/80	315A 00T/80	375-400A 00T/80
*Dimensions (WxDxH) mm		214x265x440	214x265x440	214x265x440	214x265x440	214x265x440
*Weight (kg)		15	15	15	18	18

* Rated current, dimension and weight can be changed based on power supply requirements

Size 2

Model	Input	DCREG2.410	DCREG2.500	DCREG2.600	DCREG2.900
*Armature rated current		410A	500A	600A	900A
Overload		150%	150%	150%	150%
Armature output Voltage	440 Vac	530 Vdc max	530 Vdc max	530 Vdc max	530 Vdc max
	500 Vac	600 Vdc max	600 Vdc max	600 Vdc max	600 Vdc max
	600 Vac	720 Vdc max	720 Vdc max	720 Vdc max	720 Vdc max
	690 Vac	800 Vdc max	800 Vdc max	800 Vdc max	800 Vdc max
Field rated current		35A	35A	35A	35A
Field output voltage	500 Vac	425 Vdc max	425 Vdc max	425 Vdc max	425 Vdc max
AC fast fuses		450A 2T/80	550A 2T/80	630A 2T/80	900A 3T/80
DC fast fuses		550A 2T/80	700A 2T/80	800A 2T/80	1250A 3T/80
*Dimensions (WxDxH) mm		330x360x596	330x360x596	330x360x596	330x360x596
*Weight (kg)		38	45	45	45

Size2A

Model	Input	DCREG2.1200
*Armature rated current		1200A
Overload		150%
Armature output Voltage	440 Vac	530 Vdc max
	500 Vac	600 Vdc max
Field rated current		35A
Field output voltage	500 Vac	425 Vdc max
AC fast fuses		1100A 3T/80
DC fast fuses		1400A 3T/80
*Dimensions (WxDxH) mm		333x453x685
*Weight (kg)		51

Size MODULAR.S

Model	Input	DCREG2.1050S	DCREG2.1600S	DCREG2.1800S	DCREG2.2000S	DCREG2.2300S
*Armature rated current		1050A	1600A	1800A	2000A	2300A
Overload		125%	125%	125%	125%	125%
Armature output Voltage	500 Vac	n.d.	600 Vdc max	600 Vdc max	600 Vdc max	600 Vdc max
	600 Vac	720 Vdc max	720 Vdc max	720 Vdc max	720 Vdc max	720 Vdc max
	690 Vac	800 Vdc max	800 Vdc max	n.d.	800 Vdc max	800 Vdc max
Field rated current		35A	35A	35A	35A	35A
Field output voltage	500 Vac	425 Vdc max	425 Vdc max	425 Vdc max	425 Vdc max	425 Vdc max
AC fast fuses		Included	Included	Included	Included	Included
DC fast fuses		Included	Included	Included	Included	Included
*Dimensions (WxDxH) mm		500x275x665 (size L)**	500x275x860 (size A)**	500x275x860 (size A)**	500x275x860 (size A)**	620x360x884 (size B)**
*Weight (kg)		57	79	79	79	124

Size MODULAR.S

Model	Input	DCREG2.2500S	DCREG2.2700S	DCREG2.3000S	DCREG2.3500S	DCREG2.4500S
*Armature rated current		2500A	2700A	3000A	3500A	4500A
Overload		125%	125%	125%	125%	125%
Armature output Voltage	500 Vac	600 Vdc max	600 Vdc max	600 Vdc max	600 Vdc max	600 Vdc max
	600 Vac	720 Vdc max	720 Vdc max	720 Vdc max	720 Vdc max	720 Vdc max
	690 Vac	800 Vdc max	800 Vdc max	800 Vdc max	800 Vdc max	800 Vdc max
Field rated current		35A	35A	35A	35A	35A
Field output voltage	500 Vac	425 Vdc max	425 Vdc max	425 Vdc max	425 Vdc max	425 Vdc max
AC fast fuses		Included	Included	Included	Included	Included
DC fast fuses		Included	Included	Included	Included	Included
*Dimensions (WxDxH) mm		620x360x884 (size B)**	712x395x945 (size C)**	712x395x945 (size C)**	784x415x1110 (size D)**	968x482x1250 (size E)**
*Weight (kg)		124	164	164	206	319

* Rated current, dimension and weight can be changed based on power supply requirements

** DCREG MODULAR.S, the control unit is to be added to the dimensions given in the table 214x265x440 (WxDxH)

DCREG4



Size 1

Model	Input	DCREG4.10	DCREG4.20	DCREG4.40	DCREG4.70
*Armature rated current		10A	20A	40A	70A
Overload		150%	150%	150%	150%
Armature output Voltage	440 Vac	460 Vdc max	460 Vdc max	460 Vdc max	460 Vdc max
	500 Vac	520 Vdc max	520 Vdc max	520 Vdc max	520 Vdc max
	600 Vac	630 Vdc max	630 Vdc max	630 Vdc max	630 Vdc max
	690 Vac	720 Vdc max	720 Vdc max	720 Vdc max	720 Vdc max
Field rated current		5A	5A	5A	5A
Field output voltage	500 Vac	425 Vdc max	425 Vdc max	425 Vdc max	425 Vdc max
AC fast fuses		35-40A 00T/80	35-40A 00T/80	35-40A 00T/80	80A 00T/80
DC fast fuses		35-40A 00T/80	35-40A 00T/80	50A 00T/80	100A 00T/80
*Dimensions (WxDxH) mm		214x265x440	214x265x440	214x265x440	214x265x440
*Weight (kg)		13	13	13	14

Size 1

Model	Input	DCREG4.100	DCREG4.150	DCREG4.180	DCREG4.250	DCREG4.350
*Armature rated current		100A	150A	180A	250A	350A
Overload		150%	150%	150%	150%	150%
Armature output Voltage	440 Vac	460 Vdc max	460 Vdc max	460 Vdc max	460 Vdc max	460 Vdc max
	500 Vac	520 Vdc max	520 Vdc max	520 Vdc max	520 Vdc max	520 Vdc max
	600 Vac	630 Vdc max	630 Vdc max	630 Vdc max	630 Vdc max	630 Vdc max
	690 Vac	720 Vdc max	720 Vdc max	720 Vdc max	720 Vdc max	720 Vdc max
Field rated current		5A	15A	15A	15A	15A
Field output voltage	500 Vac	425 Vdc max	425 Vdc max	425 Vdc max	425 Vdc max	425 Vdc max
AC fast fuses		100A 00T/80	160A 00T/80	160A 00T/80	250A 00T/80	315A 00T/80
DC fast fuses		125A 00T/80	200A 00T/80	250A 00T/80	315A 00T/80	375-400A 00T/80
*Dimensions (WxDxH) mm		214x265x440	214x265x440	214x265x440	214x265x440	214x265x440
*Weight (kg)		15	15	15	18	18

* Rated current, dimension and weight can be changed based on power supply requirements

Size 2

Model	Input	DCREG4.410	DCREG4.500	DCREG4.600	DCREG4.900
*Armature rated current		410A	500A	600A	900A
Overload		150%	150%	150%	150%
Armature output Voltage	440 Vac	460 Vdc max	460 Vdc max	460 Vdc max	460 Vdc max
	500 Vac	520 Vdc max	520 Vdc max	520 Vdc max	520 Vdc max
	600 Vac	630 Vdc max	630 Vdc max	630 Vdc max	630 Vdc max
	690 Vac	720 Vdc max	720 Vdc max	720 Vdc max	720 Vdc max
Field rated current		35A	35A	35A	35A
Field output voltage	500 Vac	425 Vdc max	425 Vdc max	425 Vdc max	425 Vdc max
AC fast fuses		450A 2T/80	550A 2T/80	630A 2T/80	900A 3T/80
DC fast fuses		550A 2T/80	700A 2T/80	800A 2T/80	1250A 3T/80
*Dimensions (WxDxH) mm		330x360x596	330x360x596	330x360x596	330x360x596
*Weight (kg)		40	48	48	48

Size 2A

Model	Input	DCREG4.1200
*Armature rated current		1400A
Overload		125%
Armature output Voltage	440 Vac	530 Vdc max
	500 Vac	600 Vdc max
	600 Vac	720 Vdc max
	690 Vac	800 Vdc max
Field rated current		35A
Field output voltage	500 Vac	425 Vdc max
AC fast fuses		1100A 3T/80
DC fast fuses		1400A 3T/80
*Dimensions (WxDxH) mm		333x453x685
*Weight (kg)		54

Size MODULAR.S

Model	Input	DCREG4.1050S	DCREG4.1250S
*Armature rated current		1400A	1250A
Overload		125%	125%
Armature output Voltage	500 Vac	n.d.	n.d.
	600 Vac	n.d.	630 Vdc max
	690 Vac	720 Vdc max	720 Vdc max
Field rated current		35A	35A
Field output voltage	500 Vac	425 Vdc max	425 Vdc max
AC fast fuses		Included	Included
DC fast fuses		Included	Included
*Dimensions (WxDxH) mm		500x275x860 (size F)**	500x275x860 (size F)**
*Weight (kg)		84	84

Size MODULAR.S

Model	Input	DCREG4.1400S	DCREG4.1600S	DCREG4.1800S	DCREG4.2000S	DCREG4.2300S
*Armature rated current		1400A	1600A	1800A	2000A	2300A
Overload		125%	125%	125%	125%	125%
Armature output Voltage	500 Vac	520 Vdc max	520 Vdc max	520 Vdc max	520 Vdc max	520 Vdc max
	600 Vac	n.d.	630 Vdc max	630 Vdc max	630 Vdc max	630 Vdc max
	690 Vac	n.d.	720 Vdc max	n.d.	720 Vdc max	720 Vdc max
Field rated current		35A	35A	35A	35A	35A
Field output voltage	500 Vac	425 Vdc max	425 Vdc max	425 Vdc max	425 Vdc max	425 Vdc max
AC fast fuses		Included	Included	Included	Included	Included
DC fast fuses		Included	Included	Included	Included	Included
*Dimensions (WxDxH) mm		500x275x860 (size F)**	500x375x1410 (size G)**	500x375x1410 (size G)**	500x375x1410 (size G)**	620x495x1434 (size H)**
*Weight (kg)		84	159	159	159	229

Size MODULAR.S

Model	Input	DCREG4.2500S	DCREG4.2700S	DCREG4.3000S	DCREG4.3500S	DCREG4.4500S
*Armature rated current		2500A	2700A	3000A	3500A	4500A
Overload		125%	125%	125%	125%	125%
Armature output Voltage	500 Vac	520 Vdc max	520 Vdc max	520 Vdc max	520 Vdc max	520 Vdc max
	600 Vac	630 Vdc max	630 Vdc max	630 Vdc max	630 Vdc max	630 Vdc max
	690 Vac	720 Vdc max	720 Vdc max	720 Vdc max	720 Vdc max	720 Vdc max
Field rated current		35A	35A	35A	35A	35A
Field output voltage	500 Vac	425 Vdc max	425 Vdc max	425 Vdc max	425 Vdc max	425 Vdc max
AC fast fuses		Included	Included	Included	Included	Included
DC fast fuses		Included	Included	Included	Included	Included
*Dimensions (WxDxH) mm		712x495x1505 (size I)**	712x495x1505 (size I)**	712x495x1505 (size I)**	784x460x1790 (taglia J)**	988x543x2070 (taglia K)**
*Weight (kg)		229	289	289	331	624

* Rated current, dimension and weight can be changed based on power supply requirements

** DCREG MODULAR.S, the control unit is to be added to the dimensions given in the table 214x265x440 (WxDxH)

CU400 clamping unit for DCREG



Option for electromagnets applications

DCREG thyristor converter can be used to power very inductive loads, such as electromagnets

Applications problems due to this type of load have been solved by a control algorithm specially developed for DCREG converters

CU400 CLAMPING UNIT FOR DCREG

A special algorithm featured by the DCREG enables solving the application problems issued by an ohmic resistor connected in series to a very high inductance. Clamping unit CU400 protects the DCREG when it is subject to dangerous overvoltage conditions generated when the current conduction mesh of the magnet unexpectedly opens. Power is cut by CU400, which avoids dangerous overvoltage conditions. The energy stored into the magnet is "absorbed" and stored in an RC-type clamping circuit, where overvoltage is limited by a capacitor and is dissipated by a resistor. To ensure proper clamping, unit CU400 must be connected directly to the converter DC side. To suppress the first current peak generated by the capacitor, this is pre-charged when connecting the main voltage of the mains (typically 400 VAC) to the relevant terminals. If a power supply conducted mesh is physically open or the connecting cables between the magnet and the converter open, the voltage arc generated by the current cut off is limited by the clamping circuit capable of suppressing overvoltage. The configuration above is typically required for electromagnets installed on bridge cranes.

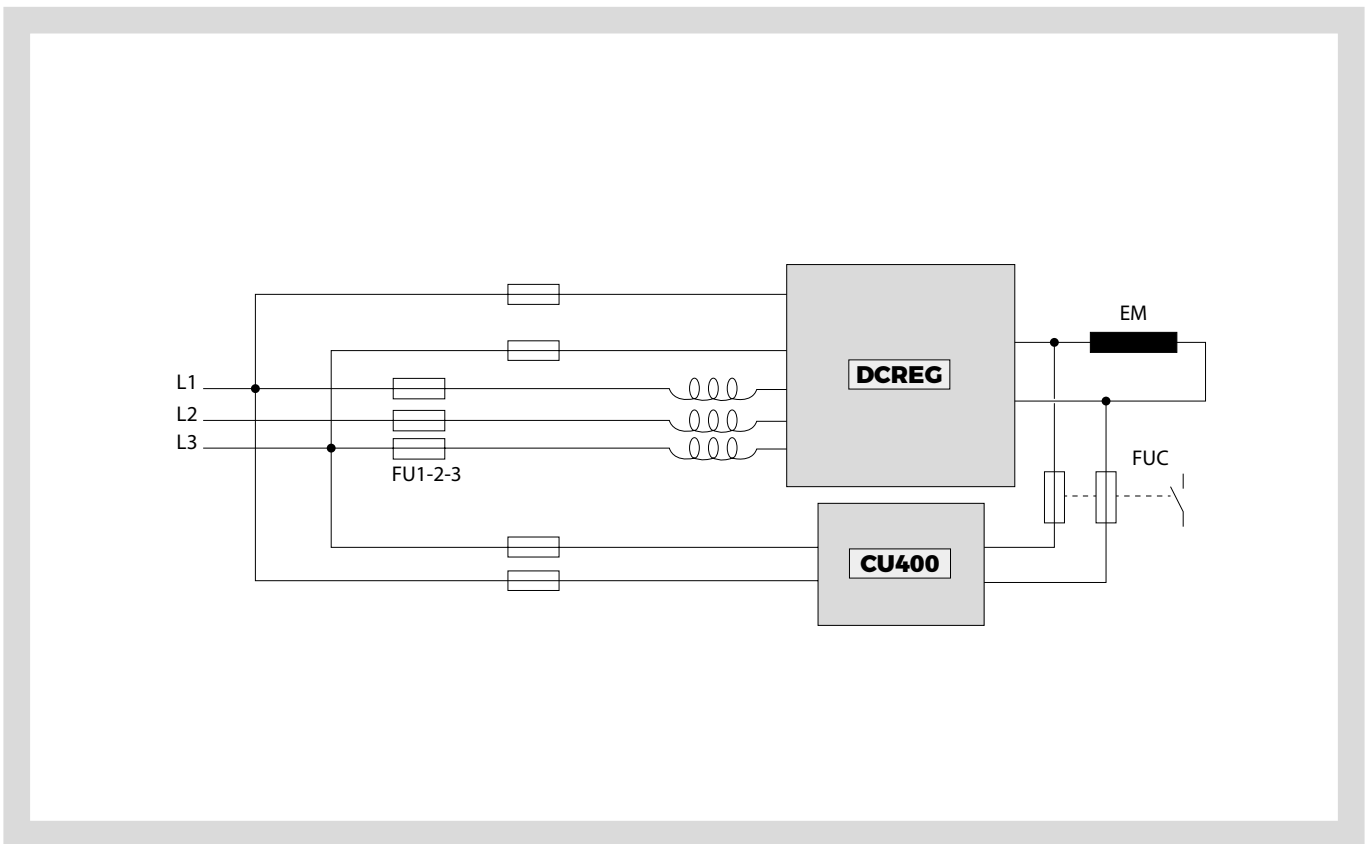

Max power supply 440 Vac

Converter size	Clamping unit	External capacitor (µF)	W (mm)	H (mm)	D (mm)	Weight (kg)
DCREG.10	CU400	-	136	246	160	3.9
DCREG.20	CU400	-	136	246	160	3.9
DCREG.40	CU400	-	136	246	160	3.9
DCREG.100	CU400	-	136	246	160	3.9
DCREG.150	CU400	2 x 3300	136	246	160	3.9
DCREG.180	CU400	2 x 3300	136	246	160	3.9
DCREG.250	CU400	2 x 6800	136	246	160	3.9
DCREG.350	2 x CU400	2 x 6800	136	246	160	3.9
DCREG.410	2 x CU400	2 x 6800	136	246	160	3.9

MJ-MA electrical motors

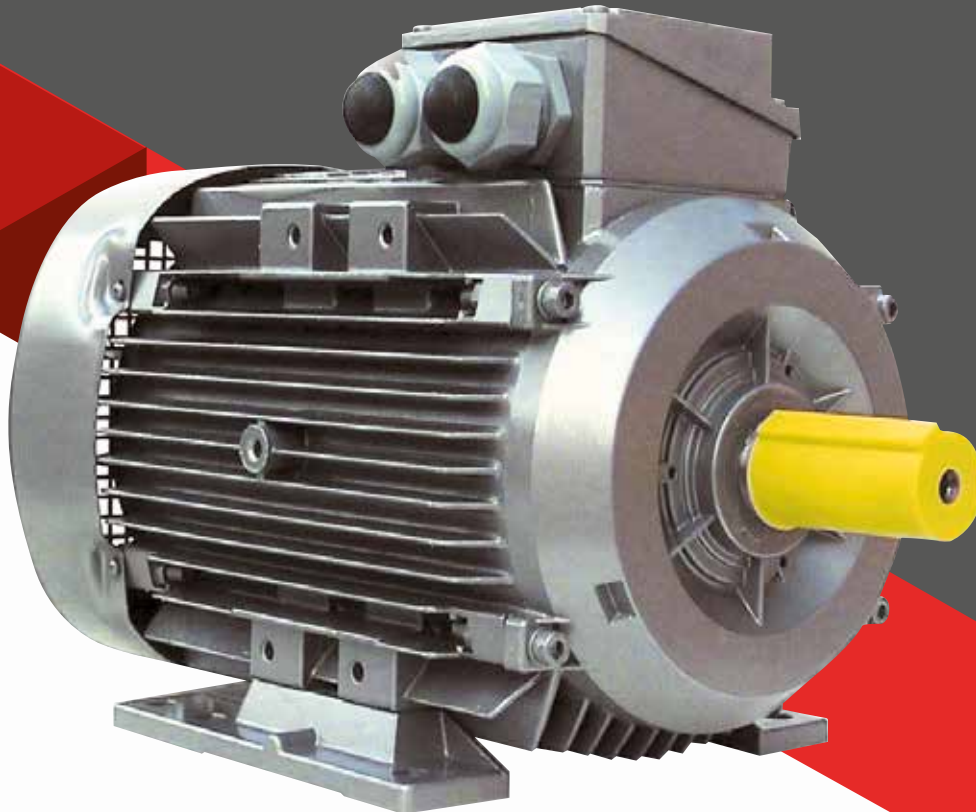

IE 2

IE 3

IE 4

Asynchronous motors

- Cage rotors
- Class F insulation
- Class B overtemperature
- IP55 protection degree
- Multivoltage 380...480 Vac (690 Vac)
- Multifrequency 50/60 Hz
- IE2, IE3, IE4 Efficiency Class

TECHNICAL FEATURES

- MJ-MA series: IEC 63...400; 0,09...900 kW; 2,4,6,8 poles, one speed
- Case IP55 size MJ 63...132 of pressure-diecast aluminium alloy with detachable feet. MA 160...400 cast iron case
- Thermal insulation class F/B
- Rated power delivered on continuous duty (S1) maximum room temperature of 40°C and maximum altitude 1000 masl
- Mounting positions: IM B3, IM B5, IM B14 and combined positions B3/B5 and B3/B14
- Bearings made by the best bearing-manufacturers provided with greaser MA 160..450 and selected for the specific use on electric motors ("SKF" o "NSK")
- Stator-winding: made with double-coated copper-wire insulated in H class, impregnation system with high quality H class (total 180°C) resins
- Windings-protection: bimetal-type thermal probes are a standard equipment on sizes MA 160...400

OPTIONS

- Customized power supply
- Additional impregnation for stator winding
- Insulation class F/H
- Bearings C3 (For radial loads)
- Bearings 2RS (Dust proof)
- Double flange motor
- Condensation drainpipe (Depending on the case and the mounting)
- Mounting position IM B35 (B3/B5)
- Mounting position IM B34 (B3/B14)
- IP56
- Internal heater
- Forced cooling
- Encoder
- Hollow tacho application
- Bimetallic thermal
- Thermal probes PTC
- Thermal probes PT100
- Water proof cover
- Insulated bearings
- Single phase motors, powers greater than 900 kW and MV motors available on demand

REMOTE DRIVE

Communication interface and management software

A programming and diagnostics utility running on Windows, for all Enertronica Santerno drives

It offers the following tools:

- data reception, transmission and saving, from a PC and to a PC
- keyboard emulator on the machine
- parameters' programming and storing
- parameters' print
- graphic display of electric values
- data logger
- firmware update

Remote service

- A simple Internet connection allows Remote Drive to get our engineers onto your plants.
- Our drives can be reached all over the world, at the cost of a local telephone call
- Accurate and simple diagnostics upon the operating state of our drives
- Remote control
- Programming assisted by expert personnel
- Graphic display of the electric values
- Possibility of configuring the remote connection, user info, PC serial port protocol and parameters

Chat

- Software that assists the real-time communication between our engineers and the technicians on the field

INDUSTRIAL SECTORS AND APPLICATIONS





INDUSTRIAL SECTORS AND APPLICATIONS

Application used for heating, ventilation and air conditioning

The standard IP54, as well as IP20, SINUS PENTA solution is perfectly suited to HVAC applications, i.e. liquid cooler fans, condenser water pump, chiller compressor, chilled water pump, supply fan, return fan.

The drive incorporates advanced PID functions for automatic control and extensive field buses communications to allow control and monitoring from a Building Management System.

The drive implements the Fire Mode function and the dual PID functions for extended operation during critical periods, thus providing the robustness and reliability required.

The drive also features the Speed Search function, allowing the drive to reach the motor speed when it is started on a rotating load.

Air Handler
Cooling Tower Fan

Pump
Water Condenser Chiller

MAIN FEATURES

- Wide power and voltage range IP54 2.2 – 250 kW (690VAC) 200-690VAC.
- IP54 standard solutions. Can be wall-mounted even close to the motor.
- 4-line alphanumeric display. Allows easy navigation, configuration, monitoring and parameter storage – easy to use and saves time.
- 5 built-in control methods (IFD, VTC, FOC, SYN, RGN). The same drive can suit the most diverse solutions.
- Built-in EMC filter. No additional external filtering required.
- 2nd PID and 2-zone PID.
- Extensive I/Os with internal comparator functions. No need for additional components.
- On-board communication.
- Fire mode operation.
- RTC (Real Time Clock) integrated with optional card.
- BACNET and METASYS® N2 communication bus boards available

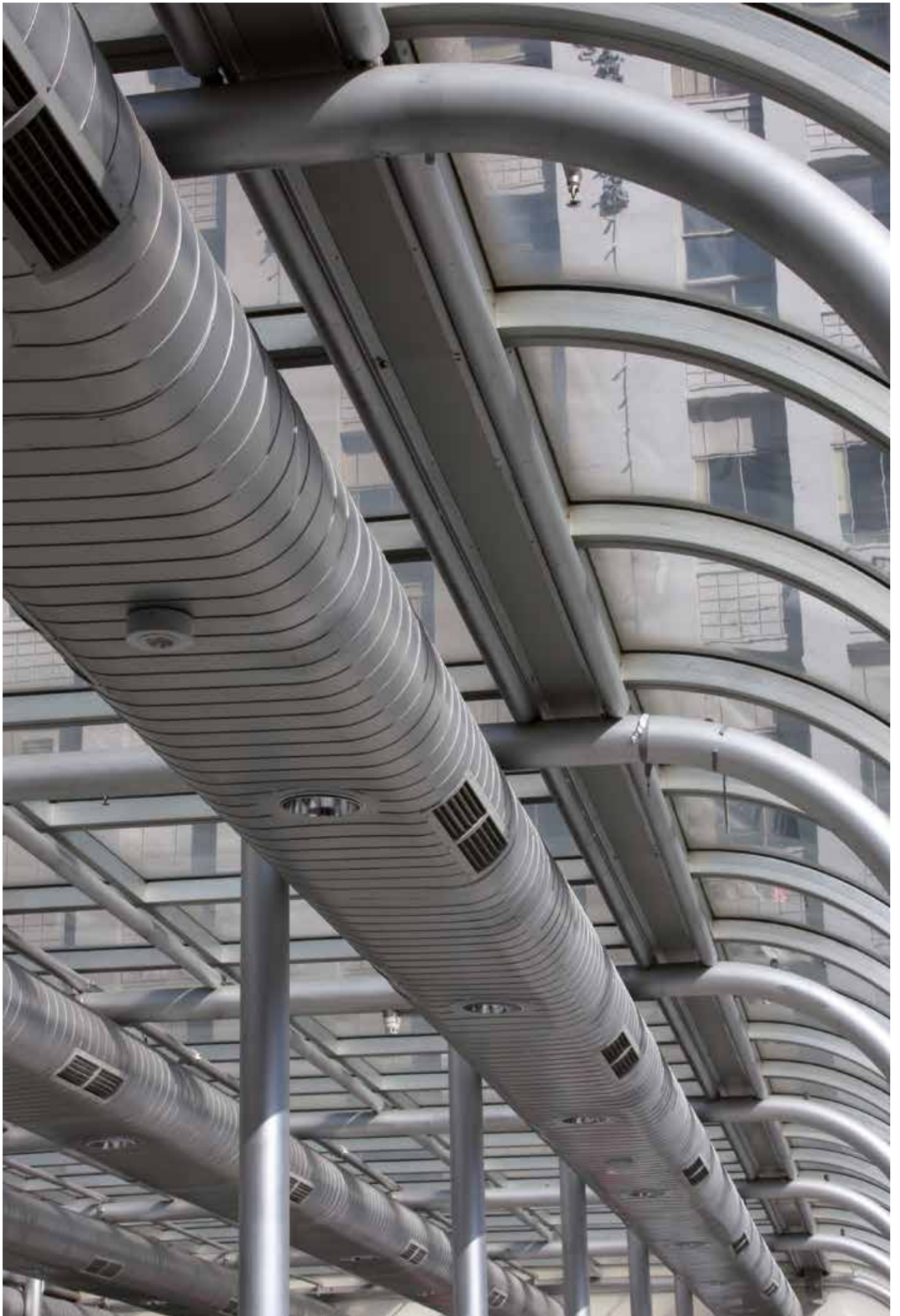

INDUSTRIAL SECTORS – WATER

The increasing demand of energy efficiency has led Enertronica Santerno to design products and accessories to fulfil the requirements for performing systems exploiting the whole water cycle. 20% of the energy demand is exploited for pumping stations.

Pumping stations shall ensure the greatest reliability and pumping capacity, as well as the most dramatic cost decrease for water supply and water treatment.

Energy saving

Using inverters is the best solution to limit the increasing expensiveness of the electric energy while enhancing energy saving. Energy efficiency, robustness, custom solutions, complete range of accessories required for the manufacture of reliable and performing systems are Enertronica Santerno's assets for large transport networks.

User-friendliness

The inverters designed and manufactured by Enertronica Santerno are very simple to use. The application wizard allows quick programming of the basic functions. The multilingual interface allows easy configuration of new systems and easy update of the existing systems.

Connectivity and system integration

Control systems typically feature reliability and safety. Enertronica Santerno meets reliability and safety requirements by using the most common field buses (PROFIDRIVE, PROFIBUS, CANOPEN, DEVICENET, ETHERNET, LONWORKS, etc). The costs for connectivity can be reduced by using additional I/Os on the inverter and made available on the serial link as well.

Pressure linearity

The electronic systems applied to motor drives suppress abrupt pressure variations in piping otherwise occurring when motors are connected directly to the mains. Pressure adjustment and ENERGY SAVER functionality dramatically reduce manufacturing costs, operation costs and maintenance costs. Enertronica Santerno products fit any stage in water cycle.

Underground water is pumped through submerged electropumps needing quick start up and very accurate control and adjustment

High pressure pumps are used in the desalination plants to obtain drinkable water

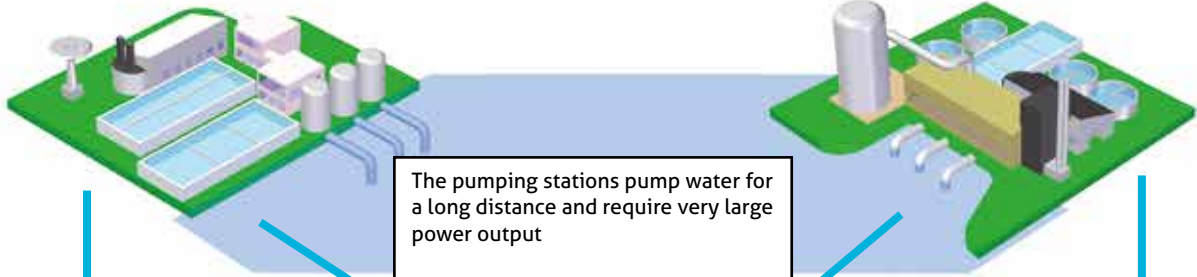

The pumping stations pump water for a long distance and require very large power output

The watering systems require even power delivery for optimum energy consumption

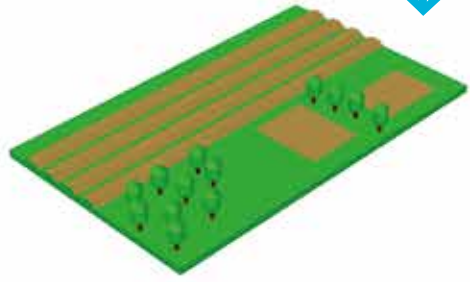
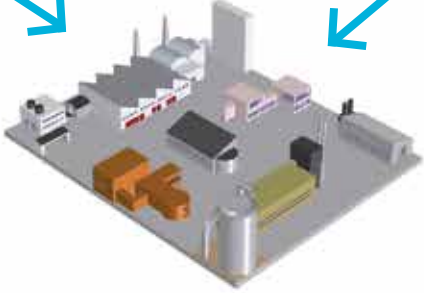

Purification plants require a wide range of products pertaining to:
Pumps - Compressor - Augers - Fans
- Mixers

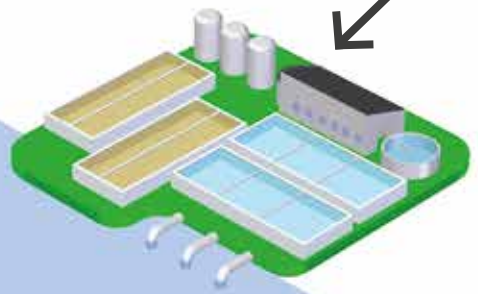
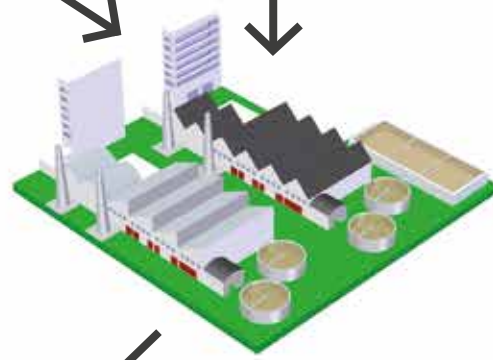

Industrial sectors - CEMENT

Santerno offers a comprehensive package of solutions, products and services for the complete primary production chain.

Stone crushers, conveyors, feeders, grinders, separators, kilns, fans, are typical applications for Santerno soft starters and SINUS PENTA in the cement industry.

Considered as integrant to the plants, facilities also include engineering consulting, either directly from the factory or from its sales network worldwide. Santerno ensures choosing the most suitable technologies and products, as well as their correct dimensioning.

This leads to dramatic money savings and adds up to a significant enhancement in a plants' economy over its lifecycle.



Industrial sectors – MINING

Santerno extensive experience and history helps professionals in the mining and minerals industry around the world to improve plant performance and production.

Santerno soft starters and premium variable speed drives like SINUS PENTA are applied to conveyors, hoists, pumps, ventilation, grinding mills, crushers in mines in Europe, South Africa, South America and Far East.

References: Cerro Lindo and Pucamarca mines in Peru, 4000 m above sea level; Elabra and Calama mines in Chile; Antiene mine Australia, 5 km regenerative belt conveyor transport coal from the mine to the power generation plant.



Applications - REGENERATIVE

Fully sinusoidal regenerative

A regenerative AC drive (also known as four-quadrant) is a drive capable of recovering energy (power) back to the mains.

The Regenerative SINUS PENTA allows bidirectional grid interface with Power Factor =1 (pure AFE application).

The pure sinusoidal waveform also allows dramatically reducing the THDI <5% and allows obtaining THDV = 0. This function is implemented in the standard SINUS PENTA drives.

Regenerative braking

The mechanical energy produced from the load is converted into electric energy and is regenerated back into the AC mains. The Motor operates as a generator.



Compliant with: CSA C22.2 No. 107.1-01 (2006) General Use Power Supplies / UL 1741 (2010) Inverters, Converters, Controllers and Interconnection System Equipment for Use With Distributed Energy Resources / IEEE 1547 (2003) Interconnecting Distributed Resources with Electric Power Systems

Cranes and winches
Conveyors
Elevators
Escalator

Power generation
Presses
Test benches
Winders



Applications – CRANES

Santerno is the ideal partner for the renovation as well as the installation of new automation systems for cranes. The STANDARD SINUS PENTA drives feature the closed-loop FOC or sensorless VTC controls, the Regenerative function and Fall prevention of the connected load. This allows operating under totally safe conditions.

Santerno can provide high qualified service before and after installation thanks to a high knowledge and excellent features of the product developed specifically for this application

The system offers

- Availability
- Productivity
- Safety
- Low operational costs



Applications - **STONE CRUSHERS**

Stone crushers require the highest torque at zero speed when they start at full load and the first rocks are to be crushed to let the mill rotate.

Two motors rotate clockwise and counterclockwise. Those motors are driven by two Sinus PENTA drives in master/slave control.

Sinus PENTA premium drives are successfully applied up to 3000 MW systems with FOC or VTC sensorless motor control and achieve top uptime and performance.



Applications - SUGAR CENTRIFUGES

Centrifuges need precise motor control at high speed with high inertia loads. During sugar season high volumes need to be produced each day.

Therefore, reducing the cycle time means increasing the number of cycles per day and production.

SINUS PENTA VSD in back to back configuration with SINUS PENTA regenerative fully sinusoidal AFE dramatically cuts the acceleration and deceleration times driving the motor

at full speed with full voltage even during grid voltage sags, regulating the steady speed with fast response to load variations and then decelerating down to zero in a very short time.

When decelerating, the motors act as generators and the energy is pushed back by the AFE into the plant electric grid and can be used by other centrifuges or electric loads, thus ensuring remarkable energy saving.



Applications - MV STEP DOWN - STEP UP

Santerno medium voltage drives, developed with the Step Down-Step Up solution, offer the perfect solution for the requirements of industries installing standard drives.

This solution allows quick installation and maintenance, as only standard components are used, which are available in Santerno's stocks worldwide, thus enhancing the product quality and reliability.



MAIN FEATURES

Frequency converter for motors

- 30...3.000 kW, 1 kV ÷ 15 kV via step up trafo
- square torque applications

Maximum losses at full load

- Inverter: 60 kW
- Filter: 6 kW

Fundamental wave content of output voltage: 95%

THDI < 12%

Reduced level of harmonics on the AC mains

BLOCK DIAGRAM

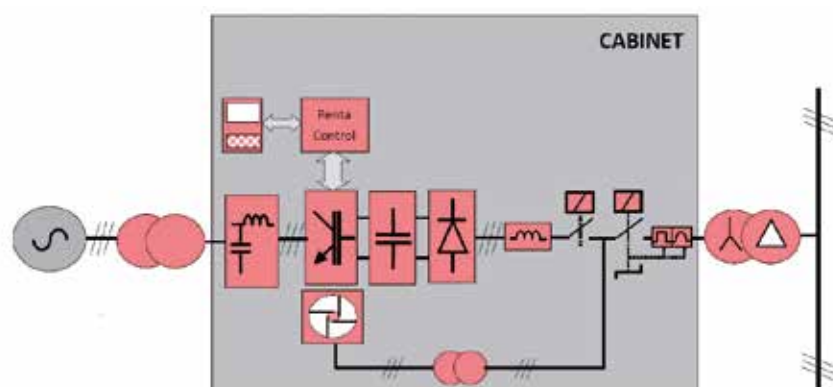



SANTERNO WORLDWIDE

HEADQUARTERS

ITALY

ENERTRONICA SANTERNO S.p.A.
Via della Concia, 7
40023 Castel Guelfo (Bologna)
T +39 0542 489711
F +39 0542 489722
info@santerno.com
www.enertronicasanterno.it

DIRECT BRANCHES

BRAZIL

**ELETRÔNICA SANTERNO
INDÚSTRIA E COMÉRCIO LTDA**
Avenida Giovanni Battista Pirelli, 271
Salas 1613 e 1614
Cep. 09111-340
Santo André – São Paulo
T +55 11 4422 4540
info@santerno.com

SPAIN

ELETRONICA SANTERNO ESPAÑA SLU
Ronda Mijares, Entresuelo Izquierda 98
12002 Castelló de la Plana, Castellon
Spain
info@santerno.com

CHILE

SANTERNO CHILE S.p.A.
Juana de Arco 2012, Of. 21
Providencia, Santiago del Chile
Chile
T +569 7109 3823
info@santerno.com

SOUTH AFRICA

SANTERNO SOUTH AFRICA (PTY) LTD
17 Indianapolis Street
Kyalami Park 1684
Midrand, South Africa
T +27 16 421 1054
info.santernosa@santerno.com

U.S.A.

ENERTRONICA SANTERNO INC.
501 Boylston Street
10th Floor, Boston MA 02116
Midrand, South Africa
W (617) 622 5223
M (978) 289 3662
bob.manasse@santerno.com

PANAMA

ENERTRONICA PANAMA SA
Punta Pacifica, Edificio Oceania
Business Plaza torre 1000, piso 29
Oficina 29-A Ciudad de Panamá
info@santerno.com

COLOMBIA

**PROGETTI INTERNATIONAL
COLOMBIA SAS**
Cra 7 # 71-21 Torre B. Of.
602 Bogotá
info@santerno.com

DISTRIBUTORS FOR INDUSTRIAL AUTOMATION

ARGENTINA

MOTORTECH S.A.
Carlos María Ramírez 2555
CP 1437 CABA
Buenos Aires, Argentina
T +54 11 4918 2299
info@motortech.com.ar
www.motortech.com.ar

AUSTRIA

GRUBER ELECTRIC GES.M.B.H.
Industriestrasse 4
A - 2542 Kottlingbrunn, Austria
T 00 43 (0) 2252 25 10 80 0
office@gruber-electric.at
www.gruber-electric.at

BELGIUM

FOCQUET SA
Rue des Haipes, 1
5030 Gembloux, Belgium
T +32(0)81625970
info@focquet.be
www.focquet.be

BOSNIA

MOMENTUM D.O.O.
Fruškogorska 55
22000 Sremska Mitrovica, Serbia
T +381 22 625 010
office@momentum-automation.com
www.momentum-automation.com

CANADA

TECO-WESTINGHOUSE MOTORS CANADA INC.
1165 Franklin Blvd., Unit A - C
Cambridge, Ontario, N1R 8E1, Canada
T +1 519 6241616
Toll Free +1 800 2684770
sales@tecowestinghouse.ca
www.tecowestinghouse.ca

CHILE

DIMET CHILE
Av. Coronel Alvarado 2384
Comuna Independencia
Santiago Del Chile, Chile
T +52 457 0808 +56 224573619 +56 224570808
dimet@dimet.cl
www.dimet.cl

COLOMBIA

GAL ELECTRIC
Carrera 7 No 67 - 39 Piso 4 Edif. OXO 69
Bogotá D.C., Colombia
T +57 1 4322097
ventas@galelectric.com.co
www.galelectric.com.co

DENMARK

RUBIX A/S
Rugaardsvej 5
8680 Ry, Danmark
T +45 76 40 87 00
dk@rubix.com
www.dk.rubix.com

EGYPT

AUTOMATION EGYPT
Zone 10, Street Hussein Kamel, flowers Tower A
Nasr City, Cairo
Egypt
T (+202) 24700816

Kuwait Branch
Kuwait, Fahheel, Makka St. Building Anoud
Office No.213
T (+965) 23926230
ashraf@automationegypt.com
www.automationegypt.com

MET - AL MAWARED ENGINEERING & TRADING S.A.E.

Head Office
3 El-Marwa Buildings, Ahmed Taysser St.
Heliopolis, Cairo, Egypt
T +202 24192480

Warehouse
12 Nakhla El Motee
Heliopolis, Cairo, Egypt
T +2 01223033988
M +2 01222112764
almawared@link.net
khalid.abdelaziz@met-eg.com
www.met-eg.org

EL SALVADOR DISSELECTRO S.A. de C.V.

Residencial Villas de Altamira Sur, Calzada
Guardabarranco, Pasaje Clarinero #14
San Salvador, 01101, El Salvador
T +503 2533 5906
ventas.sv@disselectro.com
www.disselectro.com

ENGLAND TECHNICAL SOLUTIONS 24 SEVEN LIMITED

Unit 20, Oldfield Business Park
Fenton, Stoke-On-Trent
Staffordshire, ST4 3PE, England
T +44 1782 317379
info@technicalolutions247.co.uk
www.technicalolutions247.co.uk

FINLAND

RUBIX OY
Juhanilantie 4 A 3.krs
01740 VANTAA, Finland
T +358 93 42 43 00
fi@rubix.com
www.fi.rubix.com

GERMANY

IAS-STROTHMANN E.K.
Dorstener Strasse,13
33649 Bielefeld, Germany
T +49 (521) 47 98 04
info@ias-strothmann.de
www.ias-strothmann.de

GREECE & CYPRUS

MANGRINOX S.A.
14, Grevenon Street
11855 Athens, Greece
T +30 210 3423201-3

Thessaloniki branch
Industrial area of Sindos Block 39B
Mrs. Despina Maragou
dmaragou@mangrinox.gr
T +30 2310 570 107
info@mangrinox.gr
www.mangrinox.gr

GUATEMALA

DISSELECTRO S.A. de C.V.
21 Av 2-61 Zona 11, Col. Mirador 1
01011 Ciudad de Guatemala, Guatemala
T +502 2450 1685, 2267 9708
Whatsapp: +502 5652 8293
rodolfo@disselectro.com
Negocios y Servicios Honduras y Nicaragua
Whatsapp: +502 5652 8293
rodolfo@disselectro.com
www.disselectro.com

HUNGARY

AQUALIFT KFT.
Szegedi út 108
6782 Mórahalom, Hungary
T +36 62 580 122
info@aqualift.hu
www.aqualift.hu

INDIA

BCH ELECTRIC LIMITED
1105, New Delhi House 27, Barakhamba Road
New Delhi, 110 001
India
T +91 11 23316029
marketing@bchindia.com
www.bchindia.com

IRELAND

AVONMORE ELECTRICAL CO. LTD
Roskeen, Mallow
Co Cork
Ireland
T +353 (0)2247477
john@avonmore-electrical.com
www.avonmore-electrical.com

LITHUANIA

UAB "Automatinių sistemų servisas"
Gedimino g. 47
LT-44242, Kaunas
Lithuania
T +370 619 45664
info@as-servisas.lt
www.as-servisas.lt

MACEDONIA

MOMENTUM D.O.O.
Fruškogorska 55
22000 Sremska Mitrovica,
Serbia
T +381 22 625 010
office@momentum-automation.com
www.momentum-automation.com

MALAYSIA

HI-TECH DRIVES (M) SDN BHD
36, Jalan Taboh 33/22
Shah Alam Technology Park
Seksyen 33, 40400 Shah Alam
Selangor Darul Ehsan,
Malaysia
T + 60 3 5124 9498
www.hi-tech.com.my

MEXICO

NOJOXTEN
Santa Martha, 2275
CP 45140, Colonia Santa Margarita
Zapopan, Jalisco
Mexico
T +52 33 3833 1999
ventas@nojoxten.com.mx
www.nojoxten.com.mx

G S & G Supply, SA de CV

5 de Mayo 907, Centro
64000, Monterrey, N.L.
México
T +52 81 8342 5260
M +52 81 8161 3657
gvaldesg@gsgsupply.com
www.gsgsupply.com

MONTENEGRO

MOMENTUM D.O.O.
Fruškogorska 55
22000 Sremska Mitrovica
Serbia
T +381 22 625 010
office@momentum-automation.com
www.momentum-automation.com

NORWAY

**RUBIX NORDIC HQ
& NATIONAL DISTRIBUTION CENTRE**
RUBIX AS
Nordre Brurås 18
5131 Nyborg
Norway
T +47 55 39 10 00
www.no.rubix.com

POLAND

ASTAT LOGISTYKA SP. Z O.O.
ul Dabrowskiego 441
60-451 Poznan
Poland
T +48 61 8488871
info@astat.pl
www.astat.pl

PORTUGAL

ZEMBE
Estrada da Circunvalação,
TCD, Armazém 1B
Olivais Norte
1800-136 Lisboa
Portugal
T +351 217520180
lisboa@zembe.pt
www.zembe.pt

ROMANIA

SC TRIFTECH SRL
Strada Aurel Vlaicu, Nr. 8D
Sebeş 515800
Romania
T +40 725 986 015
sales@triftech.ro
www.triftech.ro

RUSSIA

ELECTRO IMPORT LTD
Cvetochnaya Str. 16 Letter K
Saint Petersburg 196084
Russia
T +7 8123134170
info@electromatica.ru

SERBIA

MOMENTUM D.O.O.
Fruškogorska 55
22000 Sremska Mitrovica
Serbia
T +381 22 625 010
office@momentum-automation.com
www.momentum-automation.com

SPAIN

TEKSAN
Calle Francia, 150
12006 Castellón
Spain
T +34 964 250 385
teksan@teksan.es
www.teksan.es

SWEDEN

RUBIX SVERIGE AB
Kastellgatan 5
254 66 Helsingborg
Sweden
T +46 42 38 07 00
www.se.rubix.com

THAILAND

BRAINICS TECHNOLOGY CO. LTD
48/184-185 Moo1 Ramkhamhaeng Road
Sapansoong Bangkok 10240
Thailand
T +662 729 4830 3
bunditv@brainics.com
www.electronicathailand.net

TUNISIA

SEA SOCIETE D'ELECTRONIQUE ET D'AUTOMATISME
4, Rue El Khadhi Ibn Idriss Al khouleni
Cité Khaled Ibn Al Walid 2067 La Manouba
Tunisie
T +216 71 620 245
M +216 98 36 19 15
sea.azzabi@planet.tn
habib.azzabi@sea-elec.com
www.sea-elec.com

SANTERNO WORLDWIDE

SNE SOMETEL

Avenue Habib Bourguiba
Megrine 2033
Tunisie
T +216 71434154
sales@snesometel.tn
www.snesometel.tn

TURKEY

DIYANORM ELEKTRONIK SANAYI VE TICARET LIMITED SIRKETI

Taşyoncası Sok. Maslak 1453 1U T4A T4B No: 1 U
Daire: 32 Sarıyer, İstanbul
Turkey
T +90 08503055474
info@diyanorm.com
www.diyanorm.com

UKRAINE

ITAL-TECNO LTD

Tupoleva, 19
04128 Kiev
Ukraine
T +38 (095) 755 97 77
info@ital-tecno.com.ua
www.ital-tecno.com.ua

VENEZUELA

CORPORACION TEKNOMAQ, C.A.

Calle Nicaragua – Col. De Las Acacias
Local B-C - Urb. Las Acacias
01041 Caracas
Venezuela
T +58 212 693 3459/ 693 3540
teknomaq@cantv.net



Enertronica Santerno S.p.A.
Via della Concia, 7 - 40023 Castel Guelfo (BO) Italia
Tel. (+39) 0542 489711
info@santerno.com | www.enertronicasanterno.it



Follow us on LinkedIn
www.linkedin.com/company/enertronica-santerno-spa



INDUSTRIAL AUTOMATION
2024 Edition | This catalogue is subject to changes without prior notice.