

CDF3000

Operation Manual

Positioning controller

Rated current 8 A
Power supply 24 ... 48 V DC



Operation Manual CDF3000

ID no.: 1040.20B.5-00

Date: 02/2022

Valid from software version CDF V1.0

The German version is the original of this documentation.

Subject to technical change without notice.

The content of our documentation was compiled with the greatest care and attention, and is based on the latest information available to us.

We should nevertheless point out that this document cannot always be updated simultaneously with the ongoing technical development of our products.

Information and specifications may be subject to change at any time. Please obtain information about the latest version at www.keba.com

01 Supplements to the operation manual 1040.00B.4-00 CDF3000

01.1 General note about this operation manual

Chapters 1-5 and the appendix to this manual (ID. no.: 1040.20B.4-00) are based on the situation as of 08/2013.

The directives, standards and safety instructions mentioned on these pages (from page 7 to page 93) in the operation manual no longer correspond in all points to the currently required standards and safety requirements.

Individual updates to chapters 1 to 5 have been consciously avoided.

Instead, all conditions for compliance with the current product standards are combined in chapter 01.

The contents of chapter 01 replace the related referenced contents of chapters 1 to 5 in the manual (ID. no.: 1040.20B.4-00 • 08/2013)

The CDF3000 drive controllers are compliant with the current standards.

See chapter "01.8.2 Standards applied" and chapter "01.9 CE declaration".

Change notes

This chapter contains supplementary and new information related to chapters 1 to 5 in operation manual CDF3000 (ID. no.: 1040.20B.4-00 • 08/2013).

01.2 Name changes:

DriveMANAGER	->	KeStudio DriveManager
LTi	->	KEBA

01.3 Electric shock

Take protection measures against electric shock according to IEC 60364-4-41:2005/AMD1:- section 411.3. As a protection measure, use additional protective equipotential bonding as described in appendix D of IEC 60364-4-41.

01.4 PE conductor

Please take into account the local and national regulations and conditions.

01.5 Motor protection

The motor protection function acquires the motor frequency, the motor current and other parameters. Depending on these parameters and the rated motor current, the motor protection triggers the overload protection function:

- As I²T monitoring with programmable motor current, the permissible multiple of the rated motor current, the trigger time and the speed-dependency of the rated motor current.
- The I²T integrator acts as a thermal memory for the system. The thermal memory is retained while the motor is shut down and if the device is switched on.
- The devices do not retain the thermal memory if switched off, i.e. the electronic motor overload protection is reset by switching off the power supply.

The electronic motor overload protection can be increased by using a motor temperature sensor.

01.6 Braking resistor

The braking resistor must be connected using a shielded cable.

- Overcurrent protection is to be provided by suitable means.
- It is imperative the installation manual for the braking resistor is followed.
- The minimum permissible resistance for the braking resistor must not be dropped below.

01.6.1 Monitoring of the external braking resistor

The temperature of the braking resistor is to be monitored.

If the braking resistor overheats, the device must be immediately disconnected from the mains by means of suitable measures and the power stage deactivated.

01.7 Rating plate



Figure 01.1 Rating plate CDF3000 (example)

01.8 Relevant laws and standards applied

01.8.1 Ecodesign Regulation



Note:

From July 2021 the Ecodesign Regulation also applies to speed controllers (EU)2019/1781 (efficiency class IE2). The KEBA drive controllers described here do not fall under this regulation because at least one of the following points applies if used as intended:

- Operation exclusively for servomotors with speed/position feedback
- Supply with DC voltage
- Supply with single-phase AC voltage
- Supply with low voltage <100 V

01.8.2 Standards applied

On this topic, also see chapter "01.9 CE declaration".

01.9 CE declaration

EU-Konformitätserklärung MRL		 Automation by innovation	
EU Declaration of Conformity			
Der Hersteller <i>The manufacturer</i>	KEBA Industrial Automation Germany GmbH Gewerbestraße 5 - 9 35633 Lahnau Deutschland		
erklärt in alleiniger Verantwortung hiermit, dass die folgenden Produkte <i>declares under sole responsibility that the following products</i>			
Produktbezeichnung <i>Product designation:</i>	Positionierregler <i>Positioning Controller</i>		
Produkttypen	CDB3000 SH (CDB30.xxx) CDE3000 (CDE30.xxx) CDF3000 (CDF30.008)		
Product types:	CDB3000 SH (CDB30.xxx), CDE3000 (CDE30.xxx), CDF3000 (CDF30.008)		
ab Seriennummer <i>from serial number:</i>	22011xxxx 22011xxxx		
den Sicherheitsbestimmungen der nachstehenden EU-Richtlinie entsprechen: <i>comply with the essential requirements of the following EU Directive:</i>			
2006/42/EG <i>2006/42/EC</i>	Maschinenrichtlinie <i>Machinery-Directive</i>		
2014/30/EU <i>2014/30/EU</i>	EMV-Richtlinie <i>EMC-Directive</i>		
und dass folgende angeführte Normen angewandt wurden: <i>and that the following standards have been applied:</i>			
EN ISO 13849-1:2008 + AC:2009	DIN EN 61800-3:2019		
EN 62061:2005+AC:2010+A1:2013	EN 61800-5-1:2007 + A1:2017		
EN 60204-1:2006 + A1:2009+AC:2010 (in extracts)	EN 61800-5-2:2007		
Unterzeichnet für und im Namen von KEBA Industrial Automation Germany GmbH. <i>Signed for and on behalf of KEBA Industrial Automation Germany GmbH.</i>			
Unterschrift / <i>signature</i>			
Name / <i>name:</i>	Dr. Josef Wiesing	Alexander Lehmann	
Stellung: <i>position:</i>	Geschäftsführer Managing Director	Dokumentationsbeauftragter Responsible for documentation	
Datum / <i>date:</i>	15.01.2022	15.01.2022	
Adresse / <i>address:</i>	Gewerbestraße 5-9	Gewerbestraße 5-9	
Ort / <i>place:</i>	35633 Lahnau	35633 Lahnau	
Land / <i>country:</i>	Deutschland	Deutschland	
Die deutschsprachige Version dieses Dokumentes ist die Originalversion, alle anderssprachigen Versionen wurden aus dem Original-Text übersetzt. <i>The German-language version of this document is the original version, all other language versions have been translated from the original text.</i>			
Dokument:	1001.ODK.3-03-2		
FB 0108 EU-Konformitätserklärung MRL 2020/03 K Seite / Page 1 / 1			

Figure 01.2 CE declaration

01.10 Note related to chapter 1 Safety

- Awareness of national accident prevention regulations (e.g. DGUV V3 in Germany)

01.11 Note related to chapter 1.2 Intended use

When installed in machines the commissioning of the drive controller (i.e. start-up of intended operation) is prohibited, unless it has been ascertained that the machine fully complies with the provisions of the EC Directive 2006/42/EC (Machinery Directive); compliance with EN 60204 is mandatory.

Commissioning (i.e. starting intended operation) is only permitted on strict compliance with the EMC directive (2014/30/EU).

The CDF3000 conforms to the EMC Directive 2014/30/EU.

On this topic, also see chapter "01.9 CE declaration".

01.12 Note related to chapter 3.3 Connecting the power packs

The positioning controller is only allowed to be connected to power supply units (stabilised and smoothed) that satisfy the requirements for a protective extra low voltage (PELV) with safe isolation in accordance with EN 61800-5-1 or EN 50178.

01.13 Note related to chapter 3.10 Safe Torque Off (STO)

The information in chapter 3.10 Safe Torque Off (STO) is no longer valid.

On this topic pay attention to the information in the model description Description of the Safety Function STO (1001.21B.5-00 09/2020).

01.14 Note related to chapter 5 Hotline, service repair

Address: KEBA Industrial Automation Germany GmbH
Gewerbestrasse 5-9
35633 Lahnau

If you have any questions about the project planning for your machine or the commissioning of your device, our Helpline will provide you with quick, specific assistance.

The Helpline is available by e-mail or telephone:

Service hours: Mo. - Fr.: 8 a.m. - 5 p.m. (CET)

E-mail: HelpLine-DE@keba.de

Telephone: +49 6441 966-180

Internet: www.keba.com

Telephone: +49 6441 966-0

**Note:**

You will find detailed information about our services on our web site

www.keba.com → Service

Documentation overview

Document	Ordering designation	Purpose
Operation manual CDF3000	1040.20B.x-xx	Installation and commissioning
Application Manual CDE/ CDB/CDF3000	1001.22B.x-xx	Project planning and description of function
Communication manual CANopen		Project planning and description of function
Communication manual PROFIBUS-DP		Project planning and description of function

Table of contents		
1	Safety	1
2	Mechanical installation	2
3	Electrical installation	3
4	Commissioning	4
5	Diagnosis/Troubleshooting	5
Appendix: Technical data, ambient conditions UL approval		A

Date of manufacture

On the name plate on the CDF drive units you will find the serial no. from which you can read the date of manufacture using the following key.



Serial number
Calendar week
Year

Declaration of conformity

Due to the current standardisation situation, there is still no final decision from the responsible institution on whether an EC declaration of conformity is required for drive controllers with integrated safety function.

Pictograms



➔ **Attention!** Operating errors may cause damage to or malfunction of the drive.



➔ **Danger, high voltage!** Improper behaviour may cause fatal accident.



➔ **Danger from rotating parts!** The drive may automatically start.



➔ **Note:** Useful information

Table of contents

1	Safety	
1.1	Measures for your safety	1-1
1.2	Intended use	1-3
1.3	Responsibility	1-3
2	Mechanical installation	
2.1	Notes for operation	2-1
2.2	Wall mounting	2-3
3	Installation	
3.1	Connection overview	3-3
3.2	Position plan	3-4
3.3	Connection of mains units	3-5
3.3.1	Wire cross-section for X1 and X3	3-8
3.4	Motor connection	3-9
3.5	Encoder connection on LTi motors	3-10
3.5.1	Specification of interface X6	3-10
3.5.2	Connection of 2nd encoder to X6	3-12
3.5.3	Motor temperature monitoring	3-12
3.5.4	Project planning notes on encoder connection ...	3-13
3.6	Serial interface (SIO)	3-14
3.7	CAN _{open} -interface X5	3-16
3.8	Multi-axis operation	3-17
3.9	Braking resistor (RB)	3-18

3.10	Safe Torque Off (STO)	3-20
3.10.1	Danger analysis and risk assessment	3-20
3.10.2	Definition of terms	3-20
3.10.3	Description of function	3-22
3.10.4	Basic information	3-23
3.10.5	Hazard due to dangerous voltage:	3-23
3.10.6	Hazard due to axis movement at the motor:	3-24
3.10.7	Overview of "STO" connections for CDF	3-25
3.10.8	Wiring and commissioning	3-26
3.10.9	Function test STO	3-28
3.10.10	Safety-related approvals	3-29
3.11	Control connections	3-30
3.11.1	Specification of control connections	3-31
4	Commissioning	
4.1	Choosing the commissioning	4-2
4.2	Serial commissioning	4-3
4.2.1	Serial commissioning with KEYPAD	4-3
4.2.2	Serial commissioning with DRIVEMANAGER	4-5
4.3	Initial commissioning	4-6
4.3.1	Pre-set solutions	4-8
4.3.2	Setting the motor and encoder	4-11
4.3.3	Making basic settings	4-14
4.3.4	Saving the settings	4-15
4.4	Test run	4-16
4.5	Operation with KEYPAD KP300	4-20
4.6	Operation with DRIVEMANAGER	4-21
5	Troubleshooting	
5.1	LEDs	5-1
5.2	Error messages	5-2
5.3	User errors in KEYPAD operation	5-4
5.4	User errors in SMARTCARDoperation	5-4

5.5	Reset	5-5
A	Appendix	
A.1	Technical data	A-2
A.2	Ambient conditions	A-4
A.3	UL-Approbation	A-5
B	Index	

1.1 Measures for your safety

1 Safety

In order to avoid physical injury and/or material damage the following information must be read before initial start-up. The safety regulations must be strictly observed at any time.



Read the Operation Manual first!

- Follow the safety instructions!



Electric drives are generally potential danger sources:

- Rotating parts
- Hot surfaces
- Electrical voltages



Protection against magnetic and/or electromagnetic fields during installation and operation.

- For persons with pacemakers, metal containing implants and hearing aids etc. access to the following areas is prohibited:
 - Areas in which drive systems are installed, repaired and operated.
 - Areas in which motors are assembled, repaired and operated. Motors with permanent magnets are sources of special dangers.



Note: If there is a necessity to access such areas a decision from a physician is required.



Your qualification:

- In order to prevent personal injury or damage to property, only personnel with electrical engineering qualifications may work on the device.
- The qualified personnel must familiarise themselves with the Operation Manual (refer to IEC364, DIN VDE0100).
- Knowledge of the national accident prevention regulations (e. g. VBG 4 in Germany)



During installation follow these instructions:

- Always comply with the connection conditions and technical specifications.
- Comply with the standards for electrical installations, such as wire cross-section, earthing lead and ground connections .
- Do not touch electronic components and contacts (electrostatic discharge may destroy components).

Pictograms used

The notes on safety describe the following danger classes.

The danger class describes the risk which may arise when not complying with the note on safety.

Warning symbols	General explanation	Danger class acc. to ANSI Z 535
	<p>Attention! Operating errors may cause damage to or malfunction of the drive.</p>	<p>This may result in physical injury or damage to material.</p>
	<p>Danger, high voltage! Improper behaviour may cause fatal accident.</p>	<p>Danger to life or severe physical injury.</p>
	<p>Danger from rotating parts! The drive may automatically start.</p> <p>In particular, on the usage of the "automatic restart" (Autostart) function it is to be ensured that a hazard is not produced.</p>	<p>Danger to life or severe physical injury.</p>

1.2 Intended use

Drive controllers are components for installation into electric systems or machines.

When installed in machines the commissioning of the drive controller (i. e. start-up of intended operation) is prohibited, unless it has been ascertained that the machine fully complies with the regulations of the EC-directive 2006/42/EC (Machine Directive); compliance with EN 60204 is mandatory.

Commissioning (i. e. starting intended operation) is only permitted when strictly complying with EMC-directive (2004/108/EEC).



The series CDF3000 complies with the EMC directive 2004/108/EEC

The harmonized standards EN 61800-3 and EN 61800-5-1 are applied for the drive controllers.

If the drive controller is used in special applications, e. g. in areas subject to explosion hazards, the applicable regulations and standards (e. g. in Ex-environments EN 50014 "General provisions" and EN 50018 "Flame-proof housing") must be strictly observed.

Repairs must only be carried out by authorized repair workshops. Unauthorised opening and incorrect intervention could lead to physical injury or material damage. The warranty granted by LTi will become void.

1.3 Responsibility

Electronic devices are never fail-safe. The company setting up and/or operating the machine or plant is itself responsible for ensuring that the drive is rendered safe if the device fails.

EN 60204-1/DIN VDE 0113 "Safety of machines", in the section on "Electrical equipment of machines", stipulates safety requirements for electrical controls. They are intended to protect personnel and machinery, and to maintain the function capability of the machine or plant concerned, and must be observed.

An emergency stop system does not necessarily have to cut the power supply to the drive. To protect against danger, it may be more beneficial to keep individual drives running or to initiate specific safety sequences. Execution of the emergency stop measure is assessed by means of a risk analysis of the machine or plant, including the electrical equipment in accordance with EN ISO 14121, and is determined by selecting the circuit category in accordance with EN ISO 13849-1 "Safety of machines - Safety-related parts of controls".

Prior to the use of the Autostart function, the user must ensure that an automatic machine restart does not produce any hazards for the operator or machine.

2 Mechanical installation

2.1 Notes for operation2-1
 2.2 Wall mounting2-3

2.1 Notes for operation



Please ensure that ...

- no moisture enters into the device,
- no aggressive or conductive substances are in the immediate vicinity,
- no drill chippings, screws or foreign bodies drop into the device,
- the ventilation openings are not covered over.

The unit may otherwise be damaged.

Please note:

- Cooling air must be able to flow through the device without restriction.
- For mounting in switch cabinets with convection (= heat loss is discharged to the outside via the cabinet walls), always fit an internal air circulation fan.
- The backing plate must be well earthed.
- The unit is only intended for vertical installation in cabinets.
- The switch cabinet must as a minimum provide IP4x protection.



Attention: According to EN ISO 13849-2 the switch cabinet must have IP54 protection or higher when using the STO (Safe Torque OFF) safety function.

- To attain the best result for effective EMC installation use a chromated or galvanized backing plate. If backing plates are varnished, remove the coating from the contact area. The devices themselves have an aluminium rear panel.

- Maximum pollution severity 2.

Further information on environmental conditions can be found in the appendix.

2.2 Wall mounting

Step	Action	Comment
1	Mark the position of the tapped holes on the backing plate. Cut a tap for each fixing screw in the backing plate.	Dimensional drawings/hole spacing see Table 2.1 The tapping area will provide you with good, full-area contact.
2	Mount the servo regulator vertically on the backing plate.	Do not forget the mounting clearances! The metal of the contact surface must not be insulated.
3	Mount the other components, e.g. mains filter, mains choke etc. on the mounting plate.	The cable between mains filter and servo controller is allowed to be max. 30 cm long.
4	Continue with the electrical installation in section 3.	

Table 2.1 Device mounting

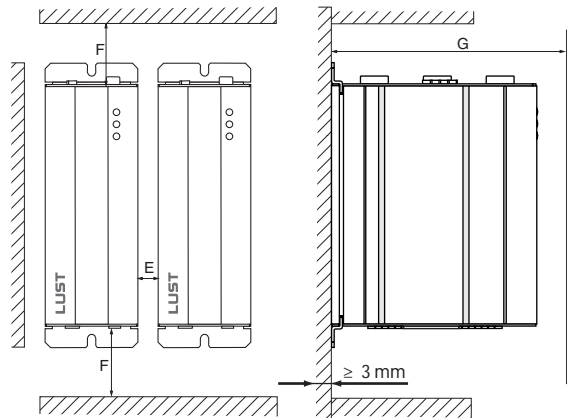
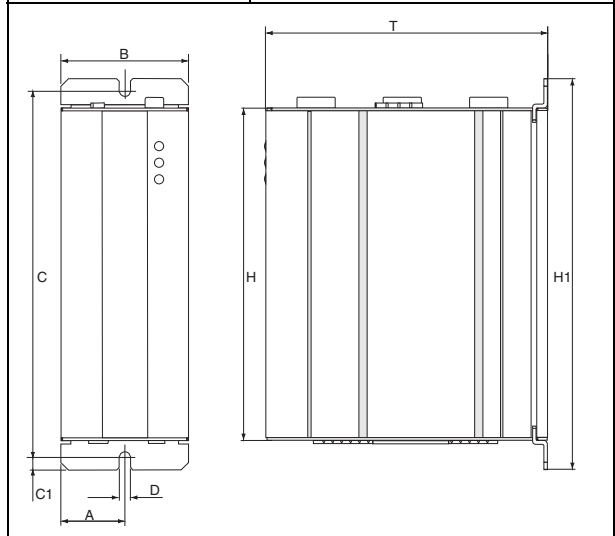

Fig. 2.1 Mounting clearances (see Table 2.2)

	CDF30.008
Weight [kg]	0.8
B (Width)	55
H (Height)	143
T (Depth)	121
A	27.5
C	157
C1	5.2
D	4.8
E	15
F	100
G	≥ 150
H1	167.5



1) for flat mounting

Table 2.2 Dimensional drawings for wall mounting (dimensions in mm)



Please note:

- Air must be able to flow through the device without restriction.
- For mounting in switch cabinets with convection (= heat loss is discharged to the outside via the cabinet walls), always fit an internal air circulation fan.
- The backing plate must be well earthed.

3 Installation

3.1	Connection overview	3-3
3.2	Position plan	3-4
3.3	Connection of mains units	3-5
3.3.1	Wire cross-section for X1 and X3	3-8
3.4	Motor connection	3-9
3.5	Encoder connection on LTi motors	3-10
3.5.1	Specification of interface X6	3-10
3.5.2	Connection of 2nd encoder to X6	3-12
3.5.3	Motor temperature monitoring	3-12
3.5.4	Project planning notes on encoder connection ...	3-13
3.6	Serial interface (SIO)	3-14
3.7	CAN_{open}-interface X5	3-16
3.8	Multi-axis operation	3-17
3.9	Braking resistor (RB)	3-18
3.10	Safe Torque Off (STO)	3-20
3.10.1	Danger analysis and risk assessment	3-20
3.10.2	Definition of terms	3-20
3.10.3	Description of function	3-22
3.10.4	Basic information	3-23
3.10.5	Hazard due to dangerous voltage:	3-23
3.10.6	Hazard due to axis movement at the motor:	3-24
3.10.7	Overview of "STO" connections for CDF	3-25
3.10.8	Wiring and commissioning	3-26
3.10.9	Function test STO	3-28
3.10.10	Safety-related approvals	3-29
3.11	Control connections	3-30
3.11.1	Specification of control connections	3-31



Attention: Installation must only be carried out by qualified electricians who have undergone instruction in the necessary accident prevention measures.

3.1 Connection overview

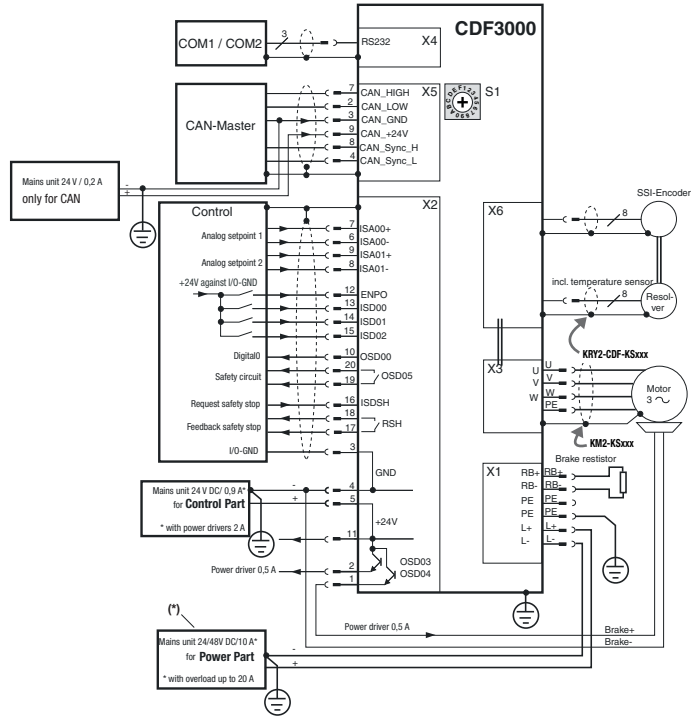

Fig. 3.1 Terminal plan CDF3000 (overview)

*In generator operation the power supply unit must be protected against overvoltage (e.g. by protective diode)

Legend	Explanation	continue
X1	Power terminal (6-pin plug-in terminal)	Page 3-5
X2	Control terminal (2 x 10-pin plug-in terminal)	Page 3-30
X3	Motor terminal (4-pin plug-in terminal)	Page 3-9
X4	RS232-port, for operation with NOTEBOOK/DRIVEMANAGER see chapter 4.5/4.6 (9-pin Sub-D socket)	Page 3-14
X5	CANopen interface with DS402 profile (9-pin Sub-D pins)	Page 3-16
S1	Encoder switch CAN-address	Page 3-10
X6	Resolver / SSI-transducer connection (15-pin Sub-D socket)	Page 3-10

Legend	Explanation	continue
⊕	Connection Protective earth (PE) Attention: Please observe chapter 3.3 "Connection of mains units".	Page 3-5

Table 3.1 Legend Terminal plan CDF3000

3.2 Position plan

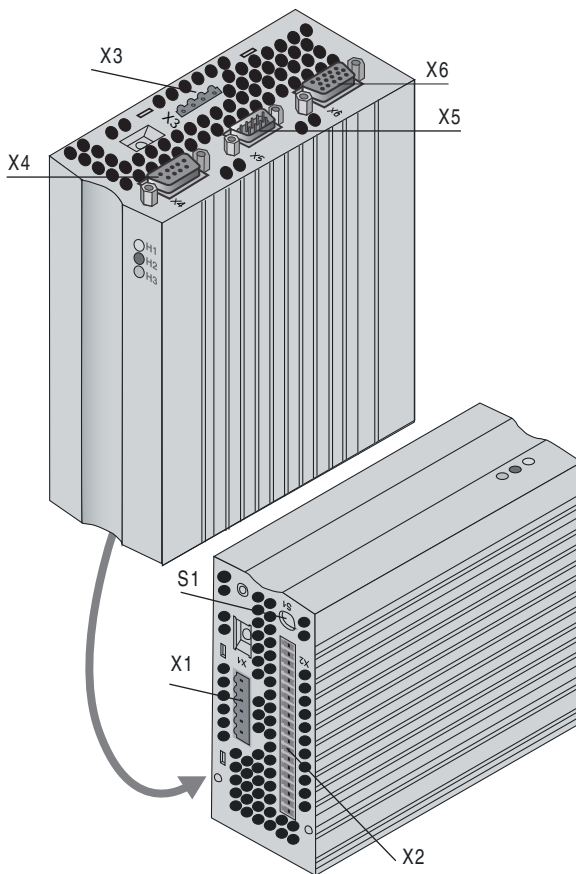

Fig. 3.2 Position plan CDF3000

3.3 Connection of mains units

The positioning drive is only allowed to be connected to power packs (stabilised and smoothed) that satisfy the requirements for a protective extra-low voltage (PELV) with safe isolation in accordance with EN 50178.

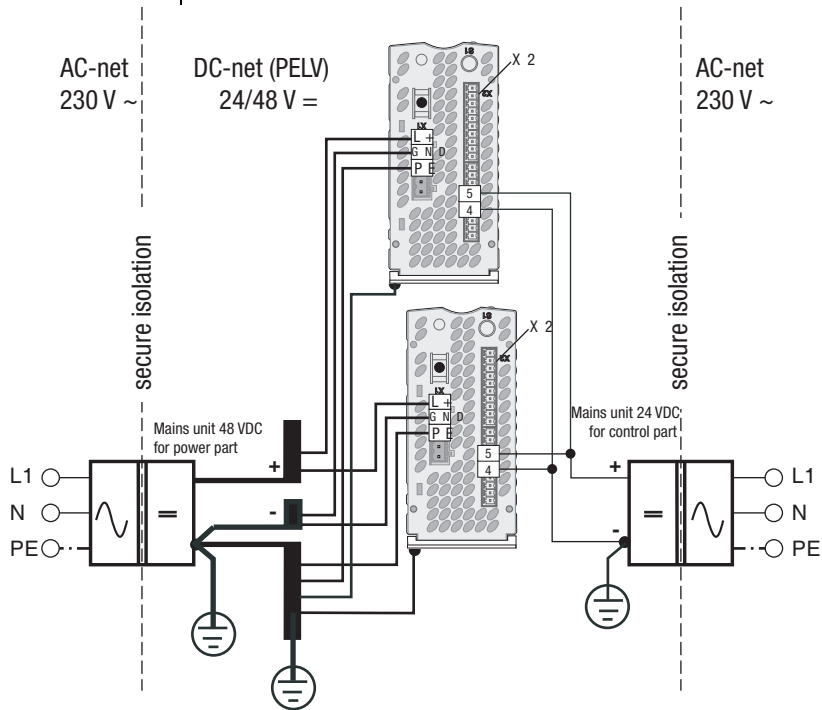

Fig. 3.3 Connection overview DC-mains supply



Note: Power side 24/48 V DC: Each unit is to be protected separately with a fuse of max. rating 16 A utilisation category gG!

Provide power to the control and power sections using a dedicated power supply unit for each!

**Please note:**

- The power supply units must be suitable for energy recovery (e.g. generator operation). The threshold for the use of the brake chopper can be up to 58 V depending on the setting in the parameter DCVIN (on this topic refer to note on page 3-7).
- Due to the large dynamic range on the DC link, the power supply unit for the power section (supply of X1) is only to be used for the operation of the CDF3000 (no other load allowed).
- Appropriate line protection must be provided in the DC mains supply. The lines must be protected with appropriate fuses.
- The earthing lead must be laid out in star configuration to conform to the EMC standards.
- The motor cable, mains lead and control cable must be laid out separately from each other.
- Avoid loops, and lay cable over short distances.
- At the supply terminal the (-) pole of the power supply units must be earthed as shown in Fig. 3.3.

**Attention: +24 V supply voltage (X2)**

For the protection of the unit against fire, a fuse with a 7 A rating is integrated in the supply voltage feed internally within the device. The breaking capacity of the fuse is limited to 30 A. If you should use a voltage source with a higher maximum current, a 6 A fuse with an appropriate breaking capacity for the power supply unit is to be provided in series. Protection of the cable is to be ensured under any circumstances!



Please note:

The brake chopper enable threshold and the selection of the braking resistor are based on the nominal supply voltage.

In the CDF3000, please first set the parameter DCIN to the nominal value for the supply voltage connected such that $U_{nom} = IDCINI$ (requirement on supply voltage: Tolerance max. $\pm 10\%$, voltage stabilised and smoothed).

Please note the setting range for the parameter DCIN (24 to 48 V DC).

The brake chopper enable threshold is then calculated as follows:
 $U_{Br} = 1.1 * IDCINI + 5.2 \text{ V}$

The overvoltage shutdown threshold is then calculated as follows:
 $U_{Sp} = 1.1 * IDCINI + 10.2 \text{ V}$

The **minimum** braking resistor allowed is defined by the following table:

DCIN	RB_{min}
24 V	2.2 Ω - 10 %
24 V to 32 V	2.7 Ω - 10 %
32 V to 40 V	3.3 Ω - 10 %
40 V to 48 V	3.9 Ω - 10 %

Table 3.2 Minimum braking resistors allowed

The CDF3000 does not have a pre-charging circuit. It does not therefore limit the charging current when the supply voltage is switched on. To utilise the current limiting in the power supply unit, the power should be switched before the power supply unit (see Fig. 3.4).

Incorrect:

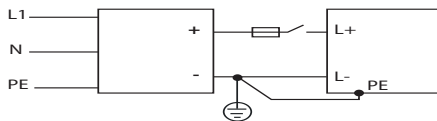

Right:

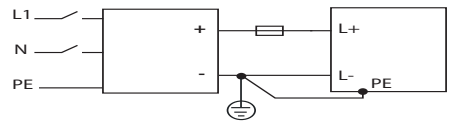

Fig. 3.4 Connection Control supply

3.3.1 Wire cross-section for X1 and X3

Positioning controller	Device connected load [kVA]	Wire cross-section [mm ²]
CDF30.008	0.55	1.5 ... 2.5

Table 3.3 Cable cross-section X1 and X3 (the local regulations and conditions are to be observed)

Lengths for stripping insulation	
X1	7 mm
X3	10 mm

Table 3.4 Lengths for stripping insulation

3.4 Motor connection



Info: The CDF3000 positioning controllers are at the terminals during operation short-circuit proof. In the event of a short-circuit or earth fault in the motor cable, the output stage is disabled and an error message is submitted.

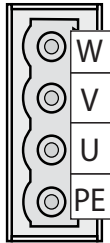

X3



Synchronous motors from LTI are optimally tuned for the positioning controller CDF3000. Prefabricated motor and encoder cables are also available. For further information on motors of series LSH and accessories please refer to the "Ordering Catalogue for Servo Motors, ID.-No. 0814.05B.x-xx".

Step	Action	Comment
1	Look for the desired synchronous motor.	There are three motors available (LST-037, LSH-050, LSH074).
2	Wire the motor phases U, V, W via a shielded cable and earth the motor to X3/PE.	Use the prefabricated motor cable for type KM2-KSxxx
3	The connection of the temperature sensor PTC or KTY is also routed through the encoder cable (see chapter 3.x.	Use the prefabricated encoder cables: KRY2-CDF-KSxxx (Resolver)

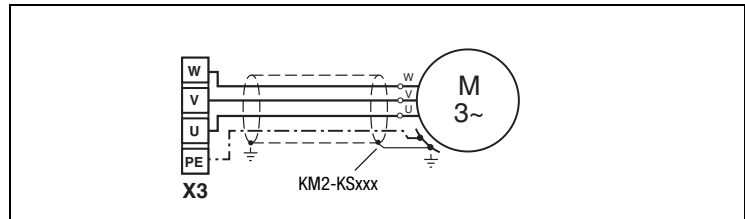

Fig. 3.5 Connection of motor

Attention: Motor phases U, V and W must under no circumstances be mixed up by mistake! With motor phases reversed the positioning controller has no control over the motor. The motor may jerk or accelerate in an uncontrolled manner ("race up").

Attention: At the motor terminals the device is not earth-fault proof !

3.5 Encoder connection on LTI motors

Step	Action	Comment
1	Select the correct encoder type.	
2	Wire the encoder connection with a shielded wire.	Use the prefabricated encoder cables: KRY2-CDF-KSxxx (Resolver)

Assignment motor - encoder cable - servo regulator connection

Compare the type plates on the components. Make absolutely sure to use the correct components!

Earth the motor cable screen on the mounting plate as close as possible to the CDF3000.



Do not separate the encoder cable, for example to route the signals via terminals in the switch cabinet. The knurled screws on the D-Sub plug housing are tightly locked!

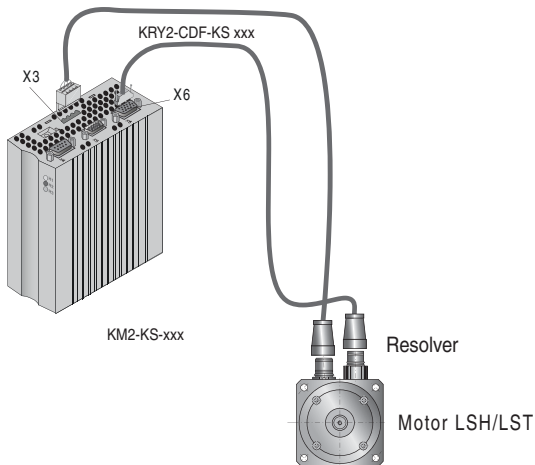

Fig. 3.6 Assignment motor/encoder cable

3.5.1 Specification of interface X6

The electrical specification of the interface is given in the Table 3.5, the terminal assignment in the Table 3.6.

	Resolver	SSI encoder
Connection	Miniature D-SUB 15-pin socket (high-density)	
Interface	-	RS422 (differential)
Wave terminating resistor	-	DATA: 120 Ω (internal) CLK: no connection necessary
Max. signal frequency f _{Grenz}	500 kHz	

Table 3.5 Specification of encoder interface X6

	Resolver	SSI encoder
Voltage supply	-	+ 5.2 V \pm 5%, max. 150 mA Not electrically isolated from the power potential (+48 V)
Scanning frequency	8 kHz	4 kHz
Interface log	-	SSI (Graycode)
Lines per revolution / resolution	-	13 bit (single turn) 25 bit (multi turn)
Max. cable length	20 m (longer lengths available on request)	

Table 3.5 Specification of encoder interface X6

The cable type for SS-encoders must be chosen acc. to the specification of the encoder manufacturer. Thereby please observe the following boundary conditions:

- Always used shielded cables. The shielding must be placed on both sides of the cable.
- Connect the differential track signals A, B or CLK, DATA to each other via twisted wires.
- Do not separate the encoder cable, for example to route the signals via terminals in the switch cabinet.



X6-Pin	Function Resolver	Function SSI	Function TTL
1	Sine- (S4)	-	
2	Sine+ (S2)	-	
3	-	+5V (150 mA)	+ 5 V (150 mA)
4	-	DATA+	A+
5	-	DATA-	A-
6	Cosine- (S3)	-	
7	REF- (R2) (Excitation-)	-	
8	-	GND	GND
9	PTC- (KTY / Klixon)	PTC- (KTY / Klixon)	
10	PTC+ (KTY / Klixon)	PTC+ (KTY / Klixon)	
11	Cosine+ (S1)	-	
12	REF+ (R1) (Excitation+ [8 kHz, approx. 7 V AC])	-	
13	n.c.	-	
14	-	CLK+	B+

Table 3.6 Assignment of encoder interface X6

X6-Pin	Function Resolver	Function SSI	Function TTL
15	-	CLK-	B-

Table 3.6 Assignment of encoder interface X6

3.5.2 Connection of 2nd encoder to X6

A SSI encoder can be evaluated on X6, parallel to the resolver connection (see chapter 3.5).

During simultaneous use the Fig. 3.7 SSI-encoder must solely be used for the positioning controller, as described in Fig. 3.7.

Motor commutation and lower level speed regulation in this case takes place via the resolver.

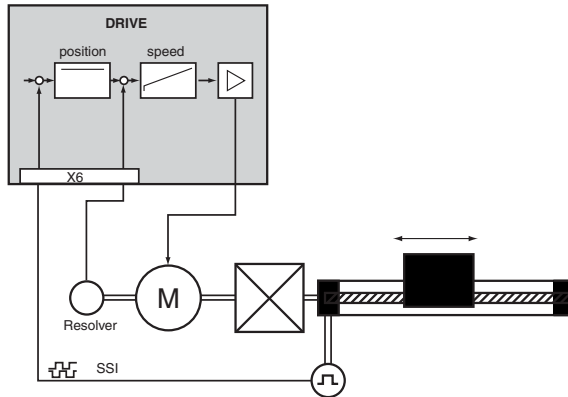

Fig. 3.7 Drive with two measuring systems

3.5.3 Motor temperature monitoring

For thermal monitoring of the motor winding a PTC-thermistor can be connected to X 6/9 and 10 via the encoder line. The type used must be set in parameter 330-MOPTC during commissioning (factory default setting is "off").

Technical data	Sensor	no PTC used	Standard PTC	linear voltage evaluation	TSS, Thermostatic circuit breaker
	Usable type	-	PTC to DIN44082	KTY84-130, (tolerance band yellow) *	Klixon
Parameter 330-MOPTC =	OFF	DIN	KTY	TSS	

Table 3.7 Motor temperature monitoring specification

Measurement voltage U_{MAX}	–	5 V	–
Error message		E-OTM	
* During the KTX evaluation the shutdown temperature can be selected between limits (150 °C ... 250 °C)			

Table 3.7 Motor temperature monitoring specification



Attention: On the usage of motors from other manufacturers, it is to be ensured the motor temperature sensor used is adequately isolated from the motor winding.

3.5.4 Project planning notes on encoder connection

The max. lines per revolution of the encoder can be calculated with the following formula.

$$SZ_{max} = \frac{60 \cdot f_{Grenz}}{n_{max}}$$

SZ_{max} = Maximum number of encoder lines in pulses per rev.
 n_{max} = maximum speed of motor in rpm
 f_{Grenz} = maximum input signal frequency of interface

Example for $n_{max} = 6000$ rpm, $f_{Grenz} = 150$ kHz:

calculated: $SZ_{max} = \frac{60 \cdot 150.000}{6000} = 1500$ Pulses/rev.

selected: An encoder with 1024 pulses/rev.

Formula to calculate the minimum displayable motor speed n_{min} , depending on the lines per revolution of the encoder.

$$n_{min} = \frac{3000}{SZ} \cdot \frac{1}{min}$$

SZ = Number of lines of encoder in pulses per rev.
 n_{min} = minimum speed of motor in rpm



Note: A speed $< n_{min}$ cannot be measured. In this range the actual speed of 0 min^{-1} is set. In the range $0 < n < n_{min}$ the amplification of the encoder is reduced.

Minimum motor speed

3.6 Serial interface (SIO)



Attention: The RS232 interface must only be used for service and commissioning. Using the interface for control purposes is not permitted.

The serial interface (SIO, X4) is used to connect a KEYPAD with SMART-CARD or a notebook with the PC-Tool DRIVEMANAGER installed. This can be used to parameterize the CDF3000.

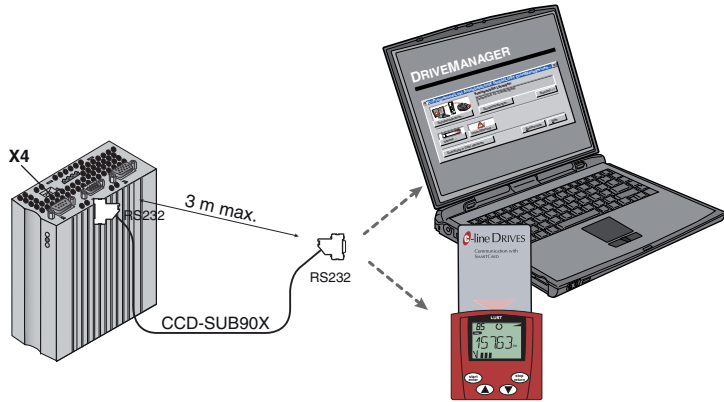

Fig. 3.8 Terminal X4

Please use only the prefabricated RS232 cable CCD-SUB 90X (max. length 3 m) to connect the positioning controller.

Pin assignment X4



Pin-No.	Function
1	+15 V DC for control unit KP200XL
2	TxD, data transmission
3	RxD, data reception
4	Do not use
5	GND for +15 V DC of the control unit KP200XL
6	Do not use
7	Do not use
8	Do not use
9	Do not use

Table 3.8 Pin assignment of the serial interface X4



Attention: The RS232 interface is connected to the potential of the control electronics (-) pole. Due to possible potential differences between the earthing of the (-) pole and the earthing of the notebook, a PE loop can be setup via the screen and the signal wires in the interface cable, and the screen earthing on the notebook. As a result the RS232, the notebook and the CDF3000 may be irreparably damaged! For this reason an opto-isolator is to be used in the interface cable (suppliers of opto-isolators are established IT accessory suppliers).

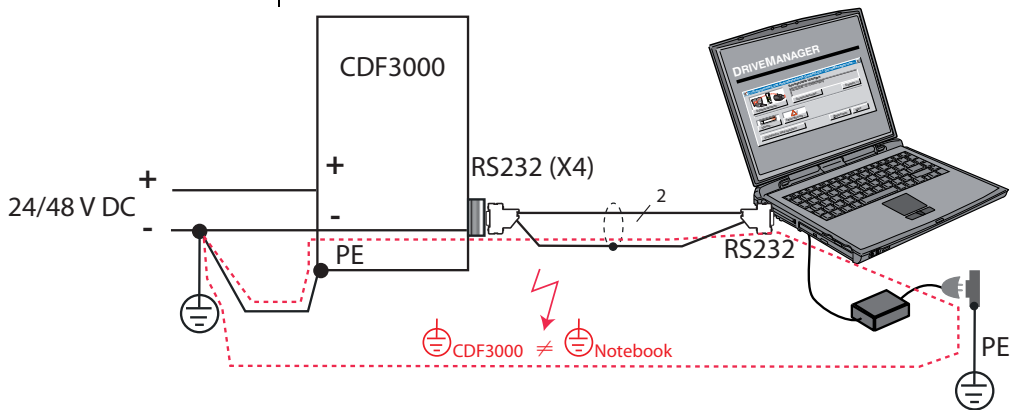

Fig. 3.9 Connection of serial interface with illustration of a PE loop

3.7 CAN_{open}-interface X5

The CAN_{open}-interface is integrated in the positioning controller. It is connected via connector X5. The customer is responsible for providing a power supply to the isolated connection.

Connection	Miniature D-Sub 9-pin
Wave terminating resistor - Bus termination -	120 Ω (internal) to be wired by customer via bridge (Pin 1-2)
Max. incoming frequency	1 MHz
Ext. Voltage supply Protective extra-low voltage (PELV) with safe isolation in accordance with EN 50178	+ 24 V ±10% / 100 mA (potential-free to drive controller)

Table 3.9 Connection CAN_{open} - interface

Assignment of terminal X5:

Pin	Function
1	Wave terminating resistor 120 Ω internally for CAN by bridge between PIN 1 and Pin 2
2	CAN_LOW
3	CAN_GND
4	CAN-SYNC_LOW This pin can optionally be switched by the micro controller as input or output.
5	Wave terminating resistor 120 Ω internally for CAN-SYNC by bridge between PIN 4 and Pin 5
6	CAN_GND
7	CAN_HIGH
8	CAN-SYNC_HIGH This pin can optionally be switched by the micro controller as input or output.
9	CAN_+24 V (24 V ±10%)

Table 3.10 Pin assignment X5

The CAN-bus node address is set via coding switch S1.

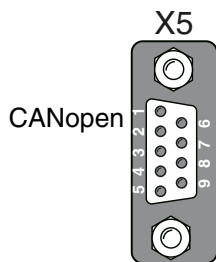

3.8 Multi-axis operation

The positioning controllers operated in multi-axis interconnection in a regenerative mode (braking operation), feed energy into the network, which is then consumed by the motor operated positioning controllers.

Interconnected operation of several positioning controllers minimises the power consumption from the mains and external braking resistors can be eliminated where appropriate.

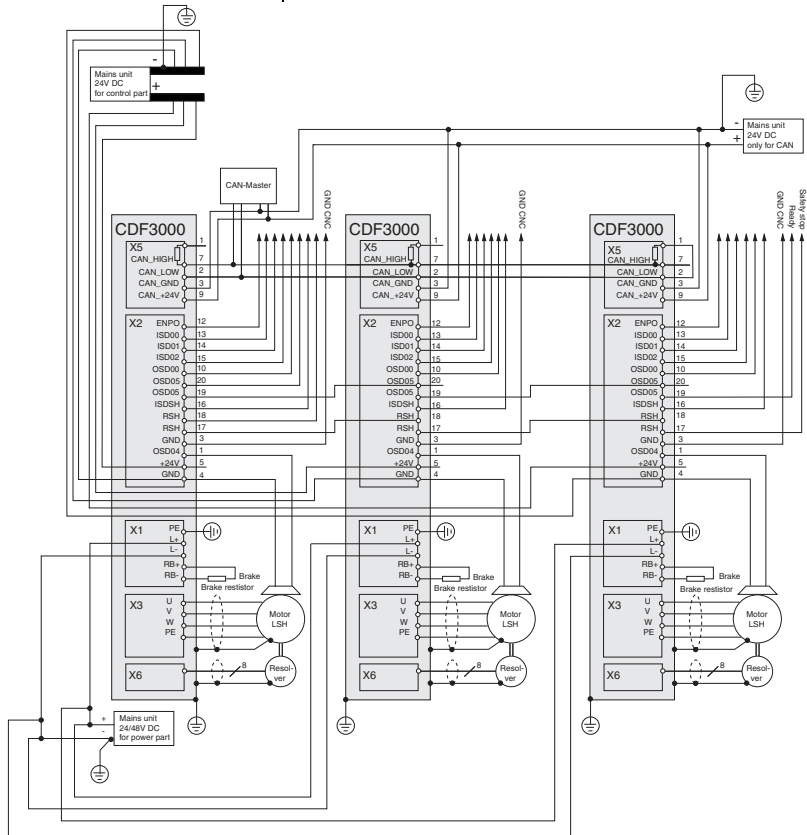

Fig. 3.10 Network plan CDF3000 (example)



Note: The instructions in 3.3 "Connecting the power packs" in particular are also to be observed!
Suitable measures are to be taken to protect the cable.

3.9 Braking resistor (RB)**Attention: Braking of the drive is of importance for the safety of machine or plant!**

The safe function of the braking facility must be tested during commissioning! In case of incorrect dimensioning (overloading) the braking resistor or the brake electronics may be destroyed and machine or plant may be damaged. Such overload (failure of the braking facility) may even cause fatal accidents or severe injury, e.g. in case of lifting applications!

In regenerative operation, e. g. when braking the drive, the motor feeds energy back to the positioning controller. This increases the voltage in the DC-link. If the voltage exceeds a threshold value, the internal braking transistor is activated and the regenerated power is converted into heat by means of a braking resistor.

The switching transistor is installed as standard. The design of the external braking resistor depends on various factors of the drive: e. g. the load to be moved, the required dynamics of the drive or the duration of braking and duty cycles.



The RB+ and RB- terminals are not short-circuit proof or overload-proof.

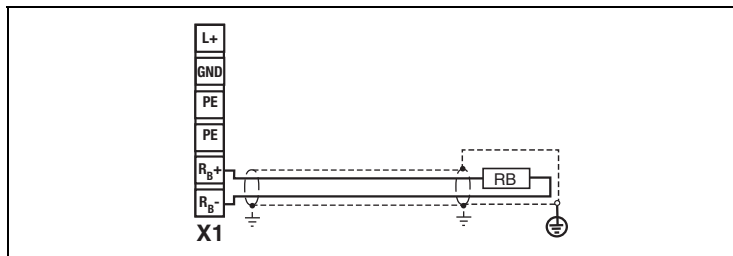

Fig. 3.11 Connection braking resistor

**Please note:**

- The design of the braking resistor must be clarified at the project planning stage.
- The minimum permissible ohmic resistance of an externally installed braking resistor for the various positioning controllers can be found in appendix A2.

For further information please consult your project engineer.



Attention: The braking resistor is to be mounted such that, in the case of the failure of the chopper transistor (e.g. if there is a "short" in the chopper transistor), the braking resistor will not represent a fire risk and measures are to be taken to electrically isolate the resistor.

1

2

3

4

5

A

DE
EN
FR
IT

3.10 Safe Torque Off (STO)

Applies to all units from hardware index 2.4.

3.10.1 Danger analysis and risk assessment

Users of the safety function (STO) must comply with the EU Machinery Directive 2006/42/EWG, or the latest applicable version as appropriate.

The manufacturer or its authorized representative is obliged to conduct a risk analysis (in accordance with the latest applicable Machinery Directive) prior to marketing a machine. An analysis of hazards posed by the machine must be conducted and appropriate measures instigated to reduce/eliminate such hazards.

With the danger analysis all prerequisites for establishing the required safety functions are fulfilled.

The CDF3000 safety function "Safe Torque Off (STO)" has been approved by the accredited certification body "TÜV-Rheinland". Conformance to parts

EN ISO 13849-1, EN 62061, EN 61800-5-1 and EN 61508 is ensured.



Qualification: The operator of the safety related system is trained in accordance with his state of knowledge, as is appropriate for the complexity and safety integrity level of the safety related system. This training includes the study of essential features of the production process and knowledge of the relationship between the safety-related system and the equipment under control (EUC).

3.10.2 Definition of terms**STO = Safe Torque OFF**

With the safety function STO the power supply to the drive is reliably interrupted immediately (no electrical isolation). The drive must not be able to generate a torque and so perform any hazardous movement. The standstill position is not monitored.

The "STO" function complies with stop category 0 in accordance with EN60204-1.



Note: see chapter 3.10.5: Hazard due to dangerous voltage and see chapter 3.10.6: Hazard due to axis movement at the motor.

Restart inhibit

Due to the restart inhibit the evaluation unit (STO) cannot be enabled after a shutdown, after a change to the machine's operation mode or after a change to the form of acknowledgement. The restart inhibit is only lifted by an external command (e.g. on button or, in LTI drive controllers, the ENPO).

Emergency stop

In accordance with the national and European preface to EN 60204-1, electrical equipment may also be used for emergency stop devices provided they comply with relevant standards, such as EN 954-1 and/or IEC 61508. "STO" can thus be used for emergency stop functions.

EN ISO 13849-1: 2008

Safety of machines, safety related parts of controls. The EN ISO 13849 standard emerged from EN 954-1, supplemented by the aspects of quality management and reliability.

EN 62061: 2006

Safety sector standard for machinery, originating from IEC 61508

IEC 61508: 2010

International basic safety standard specifying the status of safety technology in all its aspects.

EN 61800-5-1: 2007, EN61800-5-2: 2007

Electrical drives with variable speed. Part 5-1: Requirements concerning electrical, thermal and function safety.

EUC (equipment-under-control)

EUC - system:

A system that responds to the input signals from the process and/or a user and generates output signals which enable the EUC to work as desired.

EUC equipment:

Equipment, machine, apparatus or plant used for the manufacture, production and processing, transportation, medical or other activities.

EUC risk:
Risk resulting from the EUC or its interaction with the EUC operating equipment.

PFH (Probability of Failure per Hour)

Probability of Failure per Hour, in respect of a hazardous random hardware failure.

Safety function

Function performed by an E/E/PE (electrical/electronic/programmable electronic) safetyrelated system, a safety-related system of other technology or external equipment for risk minimization, with the goal of attaining and maintaining a safe state for the EUC, taking into account a particular undesired event.

Validation

Affirmation that the special requirements for a certain purpose of use are fulfilled by investigation and the submission of objective proof.

Validation describes the activity to prove that the safety-related system under investigation meets the specified safety requirements of the safety-related system in every respect, before or after installation.

Positive opening operation of a contact element

Symbol for positive opening operation according to EN 60947-5-1 annex



In a positive opening operation of a contact element, the contact separation is achieved as a direct result of a certain movement of the actuating element caused by non-elastic links (no springs).

Safety circuit

A safety circuit is designed with two channels and has been approved by accredited testing bodies on the basis of the standards. There are a large number of manufacturers offering a vast variety of safety circuits for various applications.

The positioning controllers CDE3000 and CDB3000, SH support the "STO" (Safe Torque Off) safety function according to the requirements of EN 61800-5-2, EN ISO 13849-1 "PL e" and EN 61508 / EN 62061 "SIL3".

3.10.3 Description of function

The "STO" safety function to EN 61800-5-2 describes a safety measure in the form of an interlocking or controlling function. Category 3 means that this safety function will remain in place in case a single fault occurs.

The safety-related parts must be designed in such a way that:

- a single fault in any of the said parts does not result in loss of the safety function and
- whenever feasible in an appropriate manner, the single fault is detected.

For the "STO" function the positioning controllers are equipped with additional logic circuits and a feedback contact. The logic cuts the power supply to the pulse amplifiers to activate the power stage. In combination with the controller enable "ENPO" the system uses two channels to prevent the motor creating a torque.

This variant offers the following advantages over the solution with a motor contactor:

- No need for the external motor contactor
- So less wiring
- Space-saving
- Better EMC performance due to the continuous shielding of the motor cable
- Shorter reaction time

Always draw up a validation plan. The plan specifies which tests and analyses were used by you to determine compliance of the solution with the requirements of the application.

Note: Cabinet mounting with ingress protection IP54 is essential.

3.10.4 Basic information



3.10.5 Hazard due to dangerous voltage:



- If the positioning controller is in the "STO" state all motor and mains cables, braking resistors and DC link voltage cables conduct dangerous voltages against protective conductors.
- With the "STO" function no "shutdown of voltage in case of emergency" is possible without additional measures. There is no electrical isolation between the motor and servocontroller! This means there is a risk of electric shock or other electrical risk.

KEBA**3.10.6 Hazard due to axis movement at the motor:**

- If an external effect of forces can be expected in safety function "STO", e.g. with suspended load, this motion must be reliably prevented by additional measures, e.g. by two brakes, safety bolts or a clamping device with brake.
- Despite correct shutdown, in the case of a short-circuit in two offset branches of the power section an axis movement of max. 180° may be triggered electrically.

Note: The safety circuitry connected to the servocontroller should be designed in such a way that in case of a loss of electrical supply the safe state of the machine can be reached or maintained.

3.10.7 Overview of "STO" connections for CDF

X2	Bez.
20	OSD05
19	OSD05
18	RSH
17	RSH
16	ISDSH
15	ISD02
14	ISD01
13	ISD00
12	ENPO
11	+24 V
10	OSD00
9	ISA01+
8	ISA01-
7	ISA00+
6	ISA00-
5	+24 V
4	GND
3	GND
2	OSD03
1	OSD04

The servocontroller CDF3000 offers a separate input for the "STO" request, a facility to deactivate the restart inhibit and a separate relay contact for feedback.

Des.	Term.	Specification	floating
Digital inputs			
ISDSH (STO)	X2-16	<ul style="list-style-type: none"> Request input STO = Low-level OSSD support* Switching level low/high: < 4.8 V / > 18 V DC I_{max} = typically 3 mA (at 24 V) $U_{In max}$ = 24 V +20% $R_{In nom.}$ = 3 kΩ internal signal delay time \approx 2ms Terminal scan cycle = 1 ms 	yes
ENPO (STO)	X2-12	<ul style="list-style-type: none"> Request input STO = Low-level OSSD support* Disable restart inhibit (STO) and enable power stage = High level Switching level low/high: < 4.8 V / > 18 V DC I_{max} = typically 7.5 mA (at 24 V) $U_{In max}$ = 24 V +20% $R_{In nom.}$ = 3 kΩ internal signal delay time \approx 10 ms Terminal scan cycle = 1 ms 	yes
<p>Note: In the range > 5 V / < 18 V the performance of the inputs is undefined. *OSSD: (Output Signal Switching Device) tested semiconductor outputs. Test pulses are suppressed for a period of 300 μs.</p>			

Table 3.11 X2 terminal assignment CDF3000,SH

Des.	Term.	Specification	floating
Relay outputs: Feedback signal (normally open contact) "STO"			
OSD02 (RSH)	X2-17 X2-18	<ul style="list-style-type: none"> • Diagnosis STO, both tripping channels active, one NO contact with automatically resetting circuit-breaker (polyswitch) • 25 V / 200 mA AC, utilization category AC1 • 30 V / 200 mA DC, utilization category DC1 • Operating delay approx. 10 ms • 3 x 10⁶ switching cycles 	 <p style="text-align: center;">yes</p>
Voltage supply			
Note: In the range > 5 V / < 18 V the performance of the inputs is undefined. *OSSD: (Output Signal Switching Device) tested semiconductor outputs. Test pulses are suppressed for a period of 300 µs.			

Table 3.11 X2 terminal assignment CDF3000,SH

3.10.8 Wiring and commissioning

For the "STO" function the positioning controllers are equipped with additional logic circuits and a feedback contact. The logic cuts the power supply to the pulse amplifiers to activate the power stage. In combination with the controller enable "ENPO" the system uses two channels to prevent the motor creating a torque.

The internal function of the unit and the connection for CDF3000 is shown in Fig. 3.12.

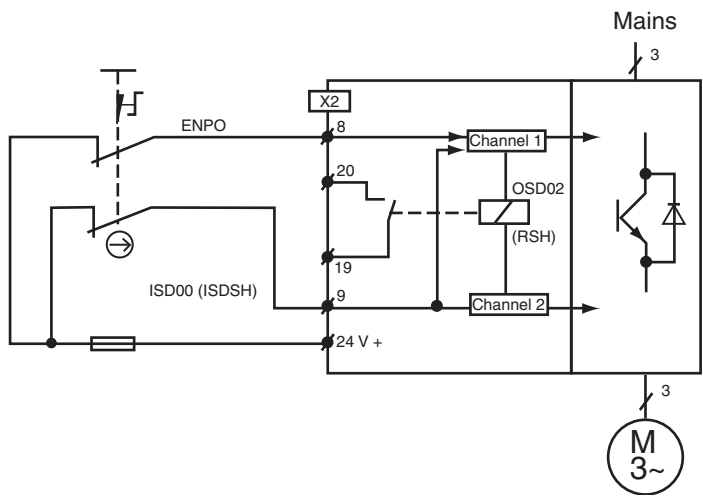

Fig. 3.12 Request "STO" on CDF3000 for shutting down in an emergency (emergency shutdown)

ENPO	ISD00 (CDF,SH)	STO	Restart inhibit	Controller state	Relay ¹⁾ OSD02 / (CDF,SH)
L	L	ON	ON	Power stage disabled via twochannels.	high
H ³⁾	H ³⁾	OFF	OFF	Power stage ready	low
(L) → H ²⁾	(L) → H ²⁾	OFF	OFF	Power stage ready	low
H	(H) → L	ON	ON	Power stage disabled via twochannels.	high
(H) → L	H	OFF	OFF	Power stage disabled via one channel.	low
(L) → H	H	OFF	OFF	Power stage ready.	low

() Previous status
 1) 3 x 10⁶ switching cycles at 200mA (rest position: NO contact)
 2) In order to deactivate the restart inhibit the control signals must be simultaneously (ENPO max. 5 ms before ISDSH) set to High (H), or ISDSH must be reliably set to High (H) before ENPO.
 3) This only applies when STO has been disabled by the process described in "2)".

Table 3.12 Logic table for operation of the "STO"



**3.10.9 Function test
STO**

The applied control signals "ISDSH" and "ENPO" must always be checked by the operator or a higher-level control for plausibility to the feedback (RSH).

The occurrence of an implausible status is a sign of a system fault (installation or servocontroller). In this case the drive must be switched off and the fault rectified.



Attention: The "STO" (Safe Torque Off) function must generally be checked for correct functionality after:

- initial commissioning
- any modification of the system wiring

replacing one or several appliances in the system.



Note: There is no protection against unexpected restarting after re-establishing the electrical power supply in the illustrated example circuit, unless an external circuit is used. If, on the restoration of the supply of power, ENPO and ISDSH are high (see truth table) and Autostart is programmed, the axis may start, particularly in the case the control electronics are supplied with 24V from an external source in event of power failure. The connected safety circuit on the machine must ensure that the servocontroller (the SRP/CS) can attain and maintain the safe state of the machine.



Note: Where the switch and drive controller are installed in different locations, it must be ensured that the cables from NC contact 1 to ENPO (STO) and from NC contact 2 to ISDSH (STO) are wired separately, or that possible faults are ruled out by using a protective tube for example.

In order to cancel the STO safety function and deactivate the restart inhibit, the ISDSH signal must be set to High before the ENPO signal, or simultaneously with it.

3.10.10 Safety-related approvals**Approval STO shutdown CDF**

Safety-related parameters in accordance with EN 62061/ EN 61508:		Safety-related parameters in accordance with EN ISO 13849:	
SIL:	3	PL:	e
HFT:	1	Category:	3
SIL:	5.5 E-10 1/h	PL:	2.907 a

Approval restart inhibit CDF

Safety-related parameters in accordance with EN 62061/ EN 61508:		Safety-related parameters in accordance with EN ISO 13849:	
SIL:	3	PL:	e
HFT:	1	Category:	3
SIL:	7.5 E-11 1/h	PL:	>10,000 a

3.11 Control connections

Step	Action	Comment
1	Please check whether you already have a SMARTCARD or a DRIVEMANAGER dataset with a complete device setup available, i.e. the drive has already been planned as required.	
2	If this is the case, a special control terminal assignment applies. Please contact your project engineer to obtain the terminal assignment.	Bulk customers For details of how to load the data set into the positioning controller refer to chapter 4.2.
3	Choose a terminal assignment.	Initial commissioning There are various pre-set solutions available to make it easier to commission the device.
4	Wire the control terminals with shielded cables. Only the signals ENPO, ISDSH and a start signal (control via terminal) are strictly required.	Earth the cable shields over a wide area at both ends. Wire cross-section maximum 1.5 mm ² or two strands with 0.5 mm ² per terminal Length for stripping insulation 7 mm.
5	Keep all contacts open (inputs inactive).	
6	Check all connections once again!	Continue with commissioning in section 4.

**Please note:**

- Always wire the control terminals with shielded cables.
- Lay the control cables separately from the mains lead and motor cable.
- The CDF3000 Application Manual presents more preset drive solutions.
- A cable type with double copper braiding with 60 - 70% coverage must be used for all screened connections.

3.11.1 Specification of control connections

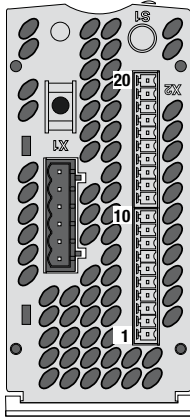

X2	Des.
20	OSD05
19	OSD05
18	RSH
17	RSH
16	ISDSH
15	ISD02
14	ISD01
13	ISD00
12	ENPO
11	+24 V
10	OSD00
9	ISA01+
8	ISA01-
7	ISA00+
6	ISA00-
5	+24 V
4	GND
3	GND
2	OSD03
1	OSD04

Control terminal X2 is located on the bottom side of the device.

Des.	Terminal X2	Specification	floating
Analog inputs, differentially			
ISA00+	7	$U_{IN} = \pm 10 \text{ V DC}$ $R_{IN} = 101 \text{ k}\Omega$ Resolution 10 Bit Terminal scan cycle = 1ms Tolerance: $U = \pm 1\%$ of end value	no
ISA00-	6		no
ISA01+	9		no
ISA01-	8		
Digital inputs			
Note: In the range $> 4.8 \text{ V} / < 18 \text{ V}$ the performance of the inputs is undefined.			
ISD00	13	<ul style="list-style-type: none"> Limit frequency 500 Hz Switching level low/high: $< 4.8 \text{ V} / > 18 \text{ V DC}$ I_{max} at 24 V = typically 3 mA internal signal delay time $\approx 100\mu\text{s}$ Terminal scan cycle = 1 ms 	yes
ISD01	14		
ISD02	15		
ENPO	12	<ul style="list-style-type: none"> Power stage enable = High-Level Switching level low/high: $< 4.8 \text{ V} / > 18 \text{ V DC}$ I_{max} at 24 V = typically 7.5 mA $R_{IN} = 3 \text{ k}\Omega$ internal signal delay time $\approx 10 \text{ ms}$ Terminal scan cycle = 1 ms 	yes
Digital outputs			
OSD00	10	<ul style="list-style-type: none"> short-circuit proof $I_{max} = 50 \text{ mA}$ internal signal delay time $\approx 250\mu\text{s}$ Terminal scan cycle = 1 ms Protection against inductive load High-side driver 	yes

Table 3.13 Specification of control connections



Des.	Terminal X2	Specification	floating	
OSD03 OSD04	2 1	<ul style="list-style-type: none"> • short-circuit proof • $I_{max} = 500 \text{ mA}$ • internal signal delay time $\approx 250\mu\text{s}$ • Terminal scan cycle = 1 ms • High-side driver • to control up to two motor holding brakes 	yes	
<p>Safe stop Note: For further information please refer also to the chapter 3.10"Safe Torque Off (STO)"</p>				
ISDSH	16	<p>"Safe Standstill" request</p> <ul style="list-style-type: none"> • Limit frequency 500 Hz • PLC-compatible • Switching level low/high: $<4.8 \text{ V} / >18 \text{ V DC}$ • I_{max} at 24 V = typically 3 mA • $R_{IN} = 3 \text{ k}\Omega$ • internal signal delay time $\approx 100\mu\text{s}$ • Terminal scan cycle = 1 ms 	yes	
RSH	18 17	<p>"Safe Standstill" feedback signal</p> <ul style="list-style-type: none"> • Relay, 1 make contact • 24 V / 0,2 A AC, utilization category AC1, $\cos \varphi = 1$ (resistive load) • 30 V / 0,2 A DC, utilization category DC1, $\cos \varphi = 1$ (resistive load) • Operating delay approx. 10 ms 	 <p>X2:18 X2:17</p>	yes
<p>Relay outputs</p>				
OSD05	20 19	<ul style="list-style-type: none"> • 24 V / 1 A AC, utilization category AC1, $\cos \varphi = 1$ • 30 V / 1 A DC, utilization category DC1, $\cos \varphi = 1$ • Operating delay approx. 10 ms 	 <p>X2:20 X2:19</p>	yes

Table 3.13 Specification of control connections

Des.	Termina I X2	Specification	floating
Voltage supply			
+24 V	5 11	<ul style="list-style-type: none"> ext. +24 V \pm 2 V Feed for control electronics strictly required for operation of the CDF3000 $I_{\max_in} = 0.9 \text{ A} + \text{currents on the outputs OSD00, OSD03 and OSD04}$ 	-
GND	3 4	<ul style="list-style-type: none"> Reference point for control electronics 	

Table 3.13 Specification of control connections

4 Commissioning

4.1	Choosing the commissioning	4-2
4.2	Serial commissioning	4-3
4.2.1	Serial commissioning with KEYPAD	4-3
4.2.2	Serial commissioning with DRIVEMANAGER	4-5
4.3	Initial commissioning	4-6
4.3.1	Pre-set solutions	4-8
4.3.2	Setting the motor and encoder	4-11
4.3.3	Making basic settings	4-14
4.3.4	Saving the settings	4-15
4.4	Test run	4-16
4.5	Operation with KEYPAD KP300	4-20
4.6	Operation with DRIVEMANAGER	4-21



Attention: Commissioning must only be carried out by qualified electricians who have undergone instruction in the necessary accident prevention measures.

4.1 Choosing the commissioning

Mode of commissioning	Commissioning steps	Continued on
<ul style="list-style-type: none">• Project planning and commissioning have already been completed.• Loading an existing data set.	Serial commissioning	Page 4-3
<ul style="list-style-type: none">• Initial project planning and commissioning of the drive system.	Initial commissioning	Page 4-6
<ul style="list-style-type: none">• Project planning and basic setting of the drive system have already been carried out.	Test run	Page 4-16

4.2 Serial commissioning

4.2.1 Serial commissioning with KEYPAD

Apply this mode of commissioning when you want to commission several identical drives (i.e. serial commissioning). The same positioning controller and motor must be set for each drive in an identical application.

If you already have a complete dataset available, please skip the paragraph "Saving dataset to SmartCard" (with KP200XL) or "Save dataset from unit to file" (with DRIVEMANAGER).

Prerequisite:

- All positioning controllers are completely connected.
- The **first** drive has already been fully taken into operation.
- The KEYPAD is directly plugged onto the positioning control (X4) via a RS232 interface.

Attention: The CARD-menu can only be selected as long as the **drive is not active!**

Saving dataset to SMARTCARD

Step	Action	Comment	Representation
1	Connect the KEYPAD to the positioning controller of the first drive, insert a SMARTCARD and switch on the mains supply.		
2	Select the CARD menu.	= load/save with the SMARTCARD	
3	Choose WRITE.	= save dataset	
4	Choose ALL and start the save operation with the <i>Start/Enter</i> key.	= complete dataset will be saved	
5	READY is displayed.	= saving completed without errors	

With this process you have written your dataset to a SMARTCARD.

KEBA

Loading dataset from SMART-CARD into next positioning controller

Step	Action	Comment	Representation
1	Connect the KEYPAD to the positioning controller of the next drive, insert a SMARTCARD with the required dataset and switch on the mains supply.		
2	Select the CARD menu.	= load/save with the SMARTCARD	
3	Choose READ.	= load dataset	
4	Choose ALL and start the load operation with the <i>Start/Enter</i> key.	= complete dataset will be loaded	
5	READY is displayed.	= loading completed without errors	
Repeat this loading process on all other drives.			



Note: The dataset is automatically saved in the positioning controller.

4.2.2 Serial commissioning with DRIVEMANAGER







Save dataset from unit to file

Load dataset from file into unit

Please remember to save the setting.

Prerequisite:

- All positioning controllers are completely connected.
- The **first** drive has already been fully taken into operation.
- A notebook with the user software DRIVEMANAGER installed is connected.

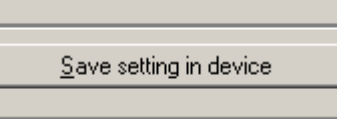
Step	Action	Comment
1	Connect your notebook with the positioning controller of the first drive and switch on the mains supply for the positioning controller (X4).	Use a standard serial cable (9-pin D-SUB, socket/plug) and an opto-isolator.
2	Start DRIVEMANAGER. If the connection setup fails you should check the settings in the menu Extras > Options and retry it via the icon.	Automatically links the connected positioning controller. 
3	Save the current dataset by clicking on the icon  , either to the parameter database (directory: c:/../userdata) of the DRIVEMANAGER or to a floppy disk (a:/.).	The icon always saves the most current dataset of the connected unit. Name the file as desired.
4a	Use this icon to disconnect from all devices 	
4b	Connect your notebook with the positioning controller of the next drive and switch on the mains supply for the positioning controller.	
5	Click on icon  to establish a link between the DRIVEMANAGER and the newly connected device.	
6	Click on icon  to load the dataset saved in step 4 into the device.	
7	Use the icon to select the main window. Save the settings with the button  ->	

Repeat steps 4 ... 7 for all further drives.



For further information concerning the DRIVEMANAGER please refer to the DRIVEMANAGER manual.

4.3 Initial commissioning

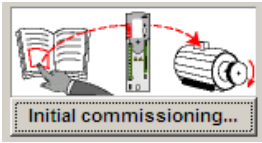

Prerequisites:

- The positioning controller is completely connected, see Chapter 3
- Installed DRIVEMANAGER from version V3.4
- The database for motors is installed on the notebook
- The unit is connected to the notebook via the RS232 interface (X4)

Attention: Never wire or disconnect electrical connections while they are live.

Input ENPO = apply Low-Level to terminal X2/12 to avoid unintended starting of the motor (output stage locked, mains voltage for positioning controller switched on).

Preparations:

- Switching on the positioning controller CDF3000.
A self-test is performed.
- Start the DRIVEMANAGER.

Set up a connection to the device.



DRIVEMANAGER

Connect

or:

Communication > Connect...



DRIVEMANAGER or:
Active device >
Change settings

Opening the main window "Setting CDF3000":

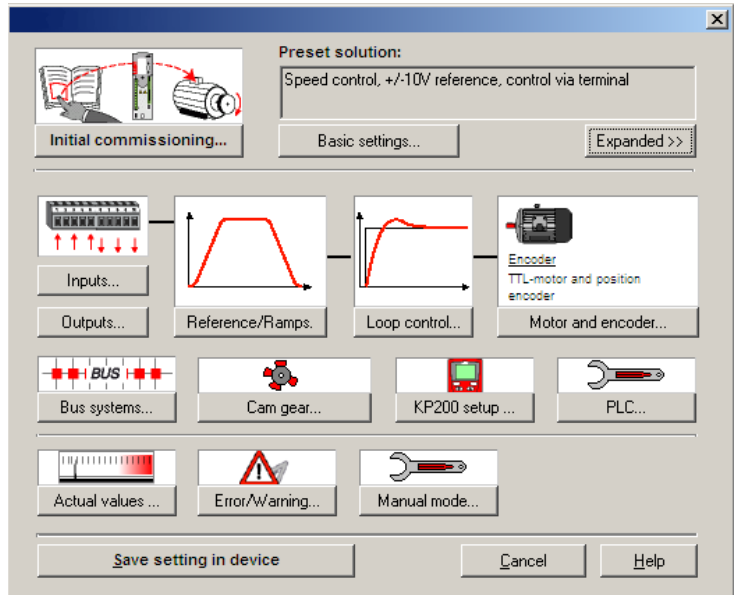
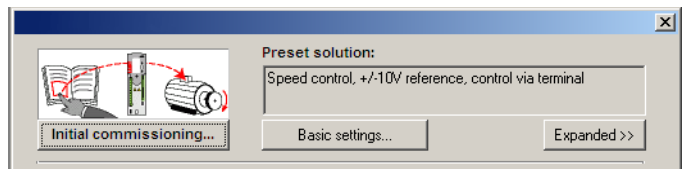

Fig. 4.1 Main window for the different settings in the DRIVEMANAGER.

Continue with:



4.3.1 Pre-set solutions



Pre-set solutions are complete parameter data sets which are provided to handle a wide variety of typical application movement tasks.

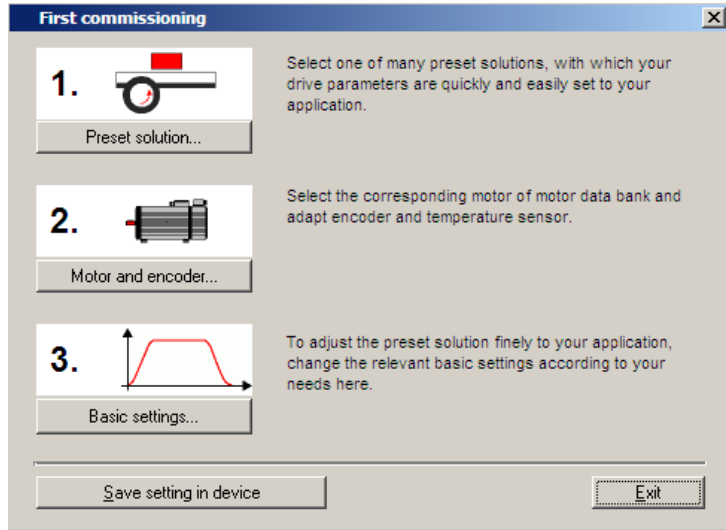

Fig. 4.2 Initial commissioning

The position controller is automatically configured by loading a pre-set solution into the random access memory (RAM). The parameters for

the control location of the drive controller,

- the reference source,
- the assignment of signal processing input and outputs and
- the type of control

are the focal points of the setting.

The use of a pre-set solution considerably simplifies and shortens the commissioning of the positioning controller. By changing individual parameters, the preset solutions can be adapted to the needs of the specific task. Pre-set solutions modified this way are stored in the unit as user datasets. In this way, you can arrive more rapidly at your desired movement solution.

A total of 20 preset solutions covers the typical areas of application for speed control with the CDF3000 controller.

Abbreviation	Reference source	Start of controller via/ Bus control profile
TCT_1	+/-10V-analog - torque	I/O-terminals
SCT_1	+/-10V-analog	I/O-terminals
SCT_2	Fixed speed table	I/O-terminals
SCC_2	Fixed speed table	CANopen field bus interface - EasyDrive-Profile "Basic"
SCB_2	Fixed speed table	Field bus options module (Profibus) - EasyDrive-Profile "Basic"
SCC_3	CANopen field bus interface	CANopen field bus interface - EasyDrive-Profile "Basic"
SCB_3	Field bus options module (Profibus)	Field bus options module (Profibus) - EasyDrive-Profile "Basic"
SCP_3	PLC	PLC
SCT_4	PLC	I/O-terminals
SCC_4	PLC	CANopen field bus interface - EasyDrive-Profile "Basic"
SCB_4	PLC	Field bus options module (Profibus) - EasyDrive-Profile "Basic"
PCT_2	Drive set tables	I/O-terminals
PCC_2	Drive set tables	CANopen field bus interface - EasyDrive-Profile "TabPos"
PCB_2	Drive set tables	Field bus options module (Profibus) - EasyDrive-Profile "TabPos"
PCC_1	CANopen field bus interface	CANopen field bus interface - DSP402-Profiles position mode - DSP402-Profiles velocity mode
PCB_1	Field bus options module (Profibus)	Field bus options module (Profibus) - EasyDrive-Profile "DirectPos"
PCP_1	PLC	PLC
PCT_3	PLC	I/O-terminals
PCC_3	PLC	CANopen field bus interface - EasyDrive-Profile "PlcPos"
PCB_3	PLC	Field bus options module (Profibus) - EasyDrive-Profile "PlcPos"

Table 4.1 Preset solutions for speed control with CDF3000

All pre-set solutions have an individual window for basic settings in DRIVE-MANAGER.

Select the pre-set solution matching your application.

1. Preset solution	
Selection for preset solution:	
SCT_1 (2)	= Speed control, +/-10V reference, control via terminal
SCT_1 (2)	= Speed control, +/-10V reference, control via terminal
SCT_2 (3)	= Speed control, fixed speeds, control via terminal
SCC_2 (4)	= Speed control, fixed speeds, control via CAN-Bus
SCB_2 (5)	= Speed control, fixed speeds, control via fieldbus module
SCC_3 (6)	= Speed control, reference and control via CAN-Bus
SCB_3 (7)	= Speed control, reference and control via fieldbus module
SCP_3 (8)	= Speed control, reference and control via PLC
SCT_4 (9)	= Speed control, reference via PLC, control via terminal
SCC_4 (10)	= Speed control, reference via PLC, control via CAN-Bus
SCB_4 (11)	= Speed control, reference via PLC, control via fieldbus module
PCC_1 (12)	= Positioning, preset of process sets and control via CAN-Bus
PCB_1 (13)	= Positioning, preset of process sets and control via fieldbus module

Fig. 4.3 Selecting the pre-set solution



Note: For more detailed information on pre-set solutions and terminal assignment please refer to the application manual CDF3000.

4.3.2 Setting the motor and encoder

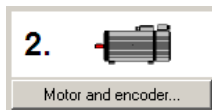

Setting up the motor data via the motor database

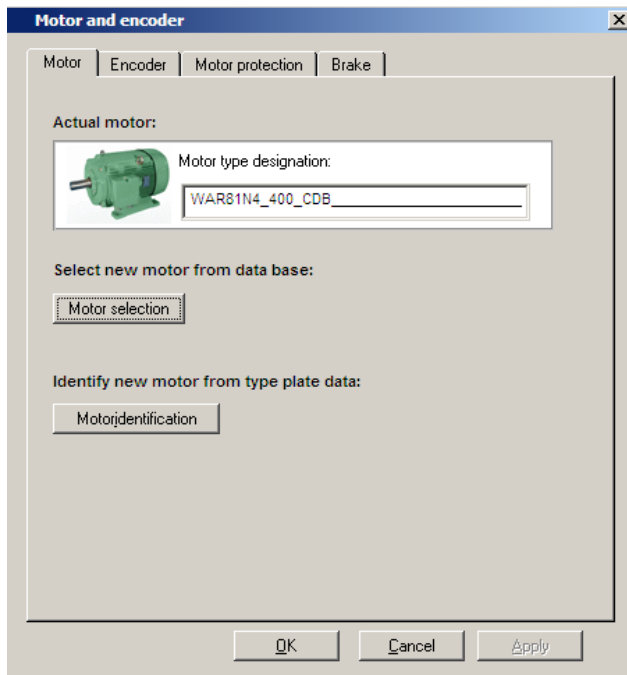

Fig. 4.4 Setting up the motor and encoder

This setting must be made if a suitable motor dataset or a complete motor database is available. Using the correct motor dataset ensures:

- that the electrical data of the motor are correctly parameterized,
- that the motor protection (tab "Motor protection") is correctly set and
- the control circuits for the drive are preset.

Note: The torque control is optimally adjusted, so that no further adaptations are required.
The setting of the speed control is based on the assumption that the moment of inertia of the machine reduced to the motor shaft is identical with the moment of inertia of the motor.
The speed and positioning controllers have a high level of attenuation and therefore also suitable for the control of elastic mechanical components.

For special settings in optimizing the speed and position circuitry you should use the application manual for the CDF3000.

The encoder connected to the motor is set in the tab "Encoder". There is also the possibility to work with two encoders. In such cases, the first rotary encoder is used for commutation and speed control of the motor (motor encoder), the second one for position control (position controller). It is also possible to perform both functions with a single encoder.

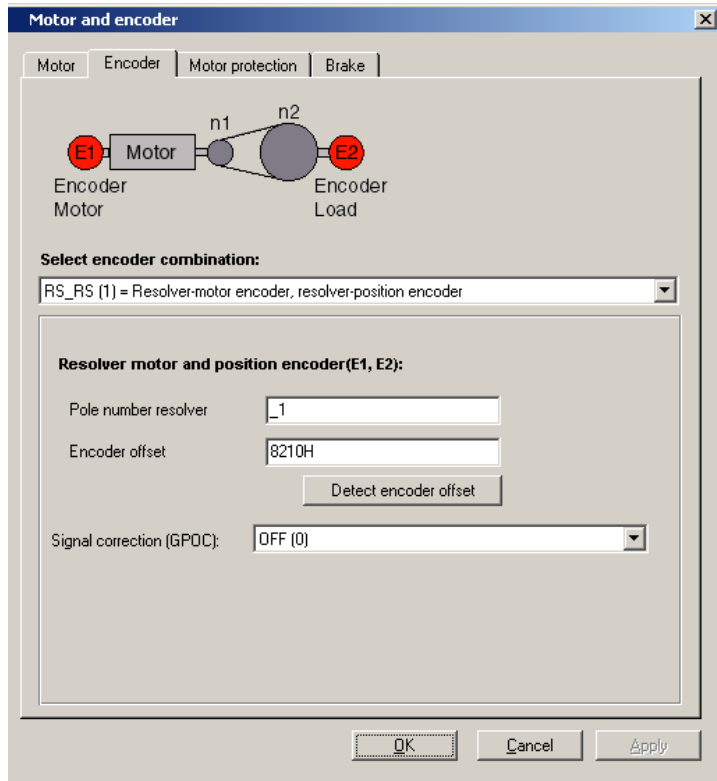

Fig. 4.5 Encoder configuration

Every rotary encoder combination has a special setup screen.

For more information on setting up the rotary encoders, refer to the CDF3000 Application Manual.



To check the encoder, rotate the motor shaft by hand.

Attention: Before the shaft is touched with the hands, the CDF3000 must be placed in the "Safe Standstill" state.

The viewing is from the front onto the end of the shaft (flange). The "CDF3000 reference and actual values" status display, under "n_{ist}, Actual speed", must indicate a positive speed in clockwise rotation and a negative speed in anti-clockwise rotation. If the speed is incorrect, check the following points:

- Is the encoder cable correctly connected to the motor and the positioning controller?
- Is the encoder cable in use the correct one for the type of encoder?

1

2

3

4

5

A

DE

EN

FR

IT

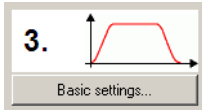
KEBA**4.3.3 Making basic settings**

Custom setup screens are provided for fine adjustment of each preset solution. You can use them to adapt the drive to your application. For a detailed description of the individual functions, refer to the CDF3000 Application Manual.

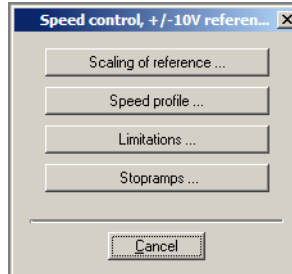

Fig. 4.6 Speed control

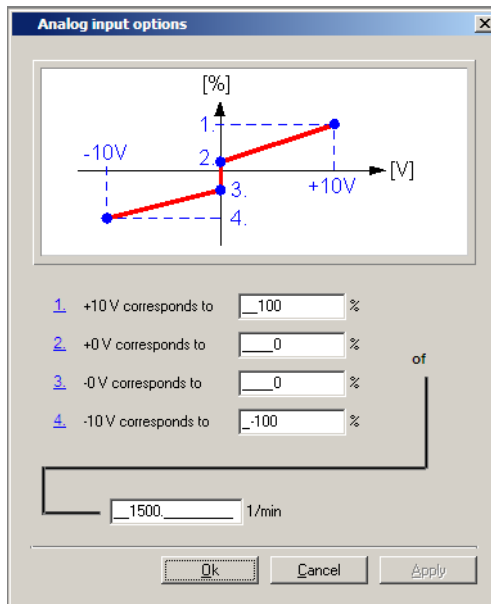

Fig. 4.7 Analogue input options

4.3.4 Saving the settings



DRIVEMANAGER
CDF3000 Settings

or:

Active device > Change settings



DRIVEMANAGER
CDF3000 Settings

or:

Active device > Save device settings in a > file

Saving the settings in the device

All changes that are to be permanently stored in the device, must be saved via the mask *CDF3000 Settings*.

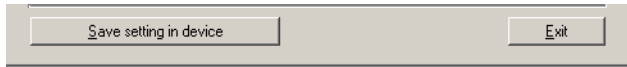

These changes can also be saved in a file.

Saving the settings in a file

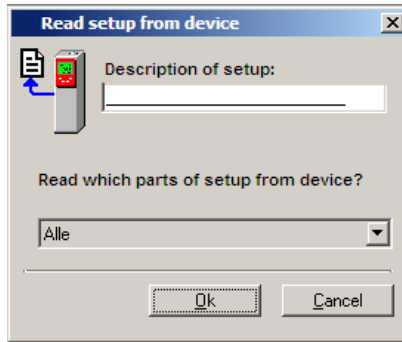

Choose the file name (e.g. mydata). All parameters are saved under the chosen file names (e.g. mydata) with the appropriate extension (*.00D). It is possible to assign a description to the device data prior to saving it.

Continue with "Test run", see chapter 4.4.

4.4 Test run**Attention: Test run with motor installed:**

In this case it must be assured that the test will not cause any damage to the system! Pay particular attention to the limitations of the positioning range.

Please note that you yourself are responsible for safe operation. LTi DRiVES Antriebstechnik GmbH will not assume liability for any occurring damage.

Danger to life from uncontrolled rotation!

Before starting motors with feather keys in the shaft end these must be reliably secured against being ejected, as far as this is not already prevented by drive elements such as belt pulleys, couplings or similar.

Pre-set solution for torque control:

In this pre-set solution the drive must not be operated without load torque, because otherwise the motor shaft would accelerate uncontrolled up to the adjusted speed limit.

**Attention: Destruction of motor:**

The motors are intended for operation on the positioning controller. Direct connection to the mains can destroy the motor. The surface temperatures on the motors may increase to a very high level. No temperature sensitive parts may touch or be mounted to these areas, appropriate measures to prevent contact must be applied wherever necessary.

A temperature sensor that may possibly be installed in the winding, must be connected to the positioning controller, so that overheating of the motor can be prevented by the temperature monitoring system.

Before starting the motor the motor brake (if present) must be checked for correct function.

The optionally installed holding brake is only designed for a limited number of emergency brake operations. Use as working brake is strictly prohibited.

The drive is tested without the coupled mechanics. The test run is conducted in the speed controlled mode, independently from the selected pre-set solution.

A test run is still possible, even if the motor has already been coupled to the system:

1. **Enable Safe Standstill**
High level on terminal X2/16
2. **Set power stage enable ENPO**
High-level at terminal X2/12

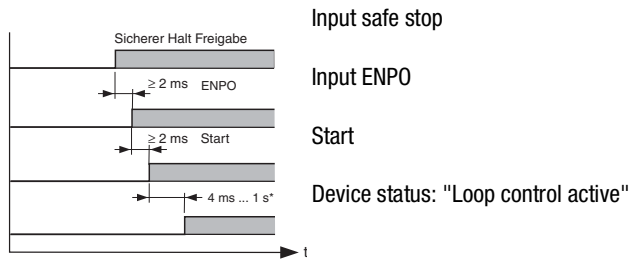

Observe the temporal behaviour of the inputs.

* After controller initialisation as a consequence of parameter change

3. **Control with DRIVEMANAGER:**
Select "speed control" and start the drive, e.g. with nominal value 100 min^{-1} .



DRIVEMANAGER
Open-loop control

or:

Active device > Open-loop control > Basic operating modes

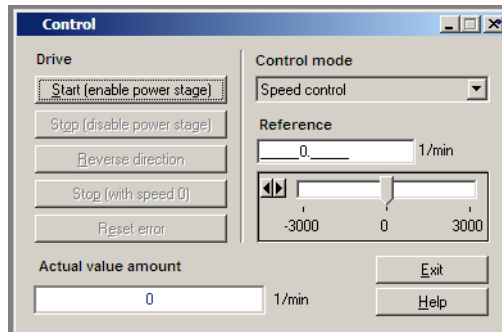

Fig. 4.8 Control



DRIVEMANAGER
Digital Scope

or:

Active device > Monitor >
Quickly changing digital scope
values

Check the drive response

Now you can assess the drive performance with the aid of step responses, which can be recorded using the digital scope function of the DRIVEMANAGER.

Select the following four recording variables:

- 0: Speed:Reference
- 1: Speed:Actual value
- 2: Torque:Reference
- 3: Torque:Actual value

Triggering condition:

Channel 0; rising flank, pre-trigger 10%; level: 30 min⁻¹

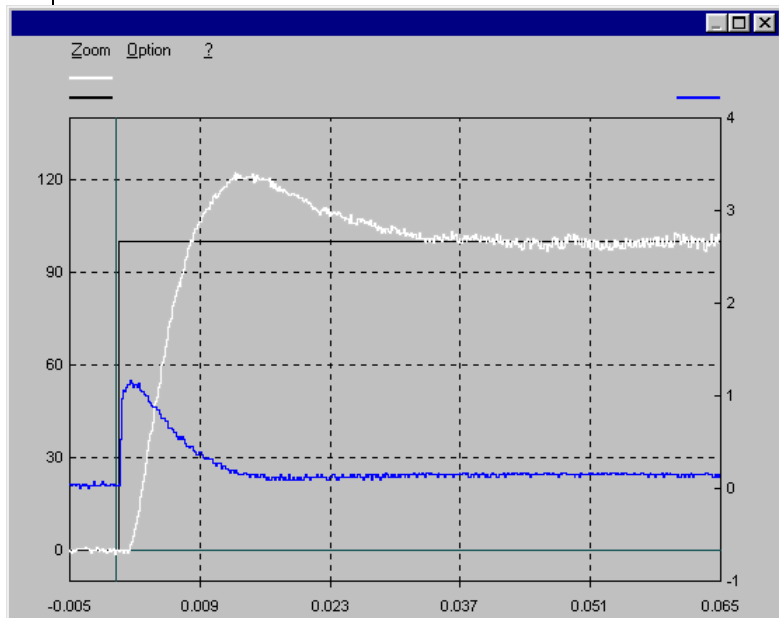

Start the drive with a reference value of e.g. 100 min⁻¹.

Compare the step response of your drive with the illustration. With resolvers the overshoot of the actual speed value should be around 20 %; with sin/cos incremental encoders approx. 30% (with reference to the nominal value). Make sure that the drive system shows small-signal response (the nominal value of the torque must be less than the maximum value).

If the torque reference reaches its maximum, reduce the speed step.

The time response (rise time, correction time) of the speed control loop is independent of the speed step.

Result:

If the step response of your drive does approximately correspond with the illustration, it is assured that the motor phases are correctly wired, the encoder is correctly connected and the CDF3000 is parameterized to the correct motor.

If the step response deviates considerably from the illustration, it is to be assumed that

- the motor dataset was incorrectly selected or
- that the wiring is incorrect.

Check the individual steps from Chapter 3 "Installation" and Chapter 4.3 "Initial commissioning" and repeat the test run.

The step response may also deviate if the ratio of the machine moment of inertia reduced onto the motor shaft relative to the motor moment of inertia is very high. Here the loop control settings must be optimized. For special settings to optimize the speed and position control loops, please use the CDF3000 Application Manual.

1

2

3

4

5

A

DE

EN

FR

IT

4.5 Operation with KEYPAD KP300

The KP 300 can be connected directly to the positioning drive (X4). You will find exact details on the individual functions and their use in the KP300 operation manual.

Overview *KEYPAD*

Designator	Summary explanation
KP300	KEYPAD with graphic display (128 x 64 pixels) for setting parameters, actual value indication and serial commissioning of the positioning drive. Display of graphics such as unit status and text for parameters. Language German or English (can be configured). The KEYPAD KP300 supports the SMARTCARD "SC-XL".

Mechanical KP300	
Dimensions (see fig.)	70 x 84 x 37 mm (W x H x D)
Weight	120 g
Connection (RS232)	
Standard (1)	Can be connected directly to the drive unit

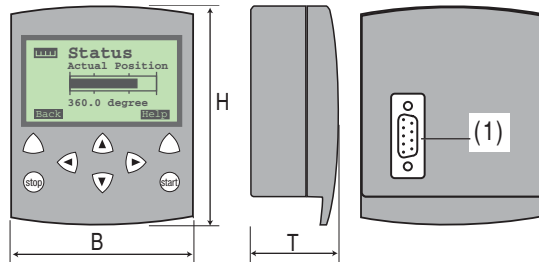

Cable connection Mounting in the cabinet door

Connection between KP300 and the positioning drive CDF3000 using the cable CCD-SUB90X

For mounting in the cabinet door, two holes for fastening screws and a cut-out for the connector are required. Please only use self-tapping screws for thermoplastics (e.g. EJOT PT screw, type K30 x 8 WN1412). Max. cable length is 3 m.

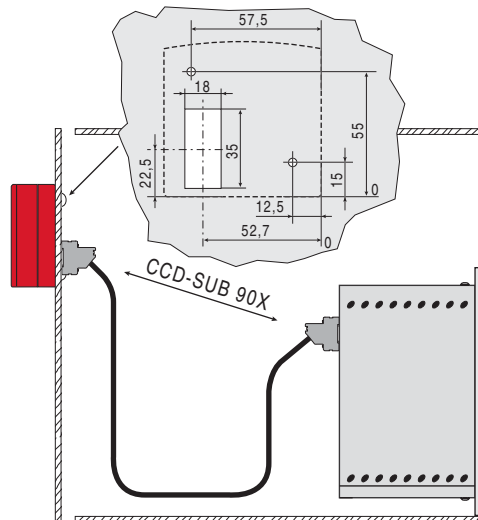

**4.6 Operation with
DRIVEMANAGER**

Attention: The RS232 interface must only be used for service and commissioning. Using the interface for control purposes is not permitted.

Prerequisite:

- DRIVEMANAGER version V3.2 or higher is installed on the notebook.
- The CDF3000 has been installed as instructed in chapter 3.

Attention: Make sure that both the CDF3000 housing as well as the GND-connection (control voltage 0V) are connected to the protective conductor potential. Otherwise the serial interface of the CDF3000 may be destroyed by potential displacement (see chapter 3.3).

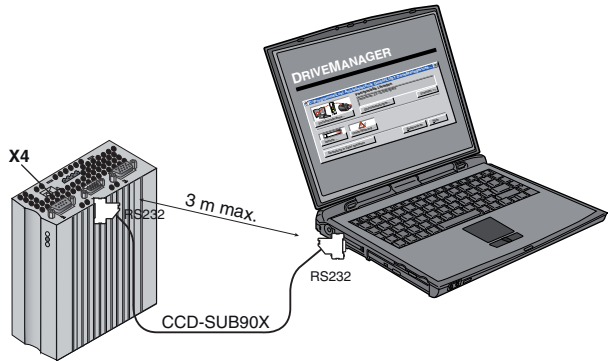

Fig. 4.9 Connection of positioning controller to notebook/DRIVEMANAGER



Attention: The RS232 interface is connected to the potential of the control electronics (-) pole. Due to possible potential differences between the earthing of the (-) pole and the earthing of the notebook, a PE loop can be setup via the screen and the signal wires in the interface cable, and the screen earthing on the notebook. As a result the RS232, the notebook and the CDF3000 may be irreparably damaged! For this reason an opto-isolator is to be used in the interface cable (suppliers of opto-isolators are established IT accessory suppliers).

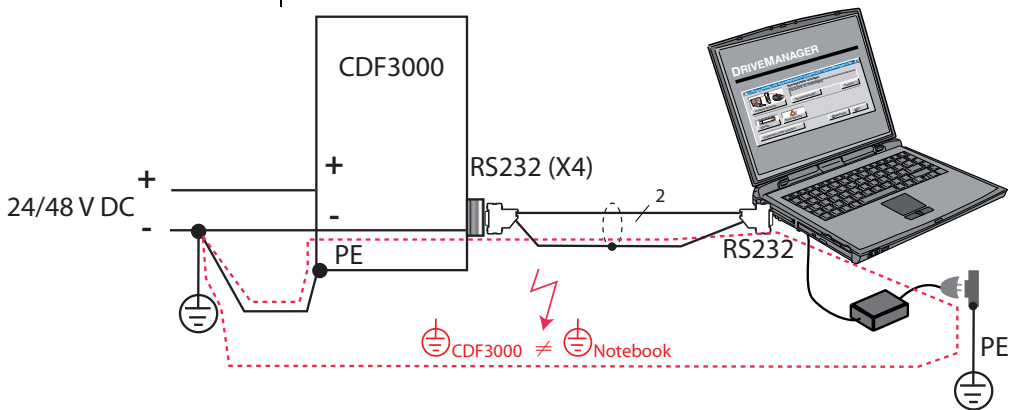











Fig. 4.10 Connection of serial interface with illustration of a PE loop

The most important functions

Icon	Function	Menu
	Changing the setting of the active device	Active device > Change settings
	Print parameter dataset	Active device > Print settings
	Digital Scope	Active device > Monitor > Quickly changing digital scope values
	Control drive	Active device > Open-loop control > Basic operation modes
	Connect to device	Communication > Connect > Single device
	Bus-initialization, Change settings	Communication > Bus-configuration
	Disconnect all devices	Communication > Disconnect
	Save dataset of active device in file	Active device > Save settings of device to
	Dataset transfer from file to active device	Active device > Load settings into device from

5 Troubleshooting

5.1	LEDs	5-1
5.2	Error messages	5-2
5.3	User errors in KEYPAD operation	5-4
5.4	User errors in SMARTCARDoperation	5-4
5.5	Reset	5-5

5.1 LEDs

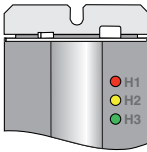

The positioning controller is fitted with three status LED's in red (H1), yellow (H2) and green (H3) at the top right.

Device status	red LED (H1)	yellow LED (H2)	green LED (H3)
Power* on	-	-	●
Ready ¹⁾	○	●	●
In service/auto-tuning active	○	*	●
Warning	●	● / *	●
Error	* (flash code)	○	●

○ LED off, ● LED on, * LED flashing

+ 24 V on control terminal X2

¹⁾ Prerequisite: "Safe Standstill" and ENPO placed beside each other.

5.2 Error messages

If an error occurs during operation it is indicated by a flash code from LED H1 (red) on the positioning controller. The code indicates the type of error. If a KP200XL is connected via an adapter, the KP200XL indicates the error type as a code.

Flash code of red LED H1	Display KEYPAD	Explanation	Cause/Remedy
1x	E-CPU	Collective error	The exact error code can be read out via the KEYPAD or the DRIVEMANAGER.
2x	E-OFF	Undervoltage shut-off	Check power supply, also occurs briefly in response to normal power-off.
3x	E-OC	Overcurrent shut-off	Short-circuit, earthing fault: Check cabling of connections, check motor coil (see also section 3, Installation). Device setup not correct: Check parameters of control circuits, check ramp setting.
4x	E-OV	Overvoltage shut-off	Voltage overload from mains: Check mains voltage, restart device. Voltage overload resulting from feedback from motor (regenerative operation): Decelerate brake ramps - if not possible use braking resistor.
5x	E-OLM	Motor protection shut-off	Motor overloaded (after I x t-monitoring): If possible slow down process cycle, check dimensioning of motor.
6x	E-OLI	Device protection shut-off	Device overloaded: Check dimensioning
7x	E-OTM	Motor temperature too high	Motor-PTC correctly connected? Parameter MOPTC correctly set (type of motor-PTC evaluation)? Motor overloaded: Allow motor to cool down, check dimensioning.
8x	E-OTI	Excessive temperature of positioning controller	Ambient temperature too high: Improve ventilation in control cabinet. Excessive load during driving/braking: Check dimensioning

1) For further information please refer also to the **CDE/CDB/CDF3000 application manual**

Table 5.1 Error messages

KEBA*Helpline**Service repair*

Contact us at the following address:

Mo.-Fr.: 8.00 a.m. to 5.00 p.m. Tel. 06441/966-180

E-Mail: helpline@lt-i.com

Fax: 06441/966-137

If you need further assistance, our specialists at the LTi-Service Center will be happy to help.

Contact us at the following address:

Mo.-Fr.: 8.00 a.m. to 5.00 p.m. Tel. 06441/966-888

E-Mail: service@lt-i.com

Fax: 06441/966-211

Note: If you need more detailed assistance and advice, you will find all the services we offer in the "Support & Service" order catalogue. You can download the order catalogue from our website, www.lt-i.com, in the section of the same name.

1

2

3

4

5

A

DE

EN

FR

IT

KEBA**5.3 User errors in
KEYPAD operation**

Error	Cause	Remedy
ATT1	Parameter cannot be changed at current user level or is not editable	Select user level 1-MODE higher.
ATT2	Motor must not be controlled via the CTRL menu	Cancel start signal from a different control location.
ATT3	Motor must not be controlled via the CTRL menu because of error state	Reset error.
ATT4	New parameter value impermissible	Change value.
ATT5	New parameter value too high	Reduce value.
ATT6	New parameter value too low	Increase value.
ATT7	Card must not be read in current state	Reset start signal.
ERROR	Invalid password	Enter correct password.

Table 5.2 User errors KEYPAD: Reset with **start/enter****5.4 User errors in
SMARTCARD operation**

Error	Meaning	Remedy
ERR91	SMARTCARD write-protected	Use different SMARTCARD
ERR92	Error in plausibility check	
ERR93	SMARTCARD not readable, wrong positioning controller type	
ERR94	SMARTCARD not readable, parameter not compatible	
ERR96	Connection to SMARTCARD interrupted	
ERR97	SMARTCARD data invalid (checksum)	
ERR98	Insufficient memory on SMARTCARD	
ERR99	Selected area not present on SMARTCARD, no parameters transferred from SMARTCARD	

Table 5.3 SMARTCARD error: Reset with **stop/return**

5.5 Reset*Parameter reset with KEYPAD**Factory setting with KEYPAD**Factory setting with
DRIVEMANAGER*

The reset function is divided into two areas with differing effects. Parameter reset restores to the last value stored in the device. Device reset restores the entire dataset to factory setting (delivery defaults).

If you are in the setup mode of a parameter and press the two cursor keys simultaneously, the parameter you are currently editing will be reset to the last setting saved (= saved with parameter 150-SAVE).

Press both cursor keys simultaneously during positioning controller power-up to reset all parameters to their factory defaults and reinitialise the system

In the "Active device" menu, the "Reset to factory setting" option can be used to restore the delivery defaults of the device.

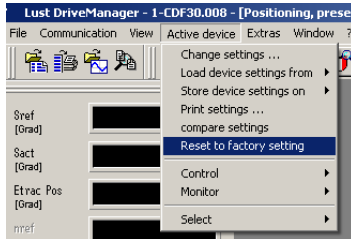

Note: Attention! This factory setting also resets the selected default solution. Check the terminal assignment and the functionality of the positioning controller in these operating modes or load your user dataset.

A Appendix

A.1	Technical data	A-2
A.2	Ambient conditions	A-3
A.3	UL-Approval	A-5

A.1 Technical data

CDF30.008

Technical data	CDF30.008
Output motor side	
Voltage	16.5 V ... 33 V AC
Continuous current effective (I_N)	8.0 A
Peak current $2 \times I_N$ for 5 s	16 A
Rotating field frequency	0 ... 400 Hz
Power stage switching frequency	8, 16 kHz
Input mains supply side (X1)	
Mains voltage	1 x 24 VDC -10 %/ 48 VDC +10 %
Device connected load	480 VA
Power loss	25 W
Brake chopper power electronics	
Minimum ohmic resistance of an externally installed braking resistor	3,9 Ω -10 % at 48 V DC 2,2 Ω -10 % at 24 V DC*
* Attention: Set DCIN parameters!	

Table A.1 Technical data



Please note:

The brake chopper enable threshold and the selection of the braking resistor are based on the nominal supply voltage.

In the CDF3000, please first set the parameter DCIN to the nominal value for the supply voltage connected such that $U_{nom} = IDCINI$

(requirement on supply voltage:

Tolerance max. $\pm 10\%$, voltage stabilised and smoothed).

Please note the setting range for the parameter DCIN (24 to 48 V DC).

The brake chopper enable threshold is then calculated as follows:

$$U_{Br} = 1.1 * IDCINI + 5.2 \text{ V}$$

The overvoltage shutdown threshold is then calculated as follows:

$$U_{Sp} = 1.1 * IDCINI + 10.2 \text{ V}$$

The **minimum** braking resistor allowed is defined by the following table:

DCIN	RB _{min}
24 V	2.2 Ω - 10 %
24 V to 32 V	2.7 Ω - 10 %
32 V to 40 V	3.3 Ω - 10 %
40 V to 48 V	3.9 Ω - 10 %

Table A.2 Minimum braking resistors allowed

1

2

3

4

5

A

DE
EN
FR
IT

A.2 Ambient conditions

Characteristic	Positioning controller	Accessories (KEYPAD KP300)
Climatic conditions	in operation as per EN 61800-2, IEC 60721-3-3 class 3K3	+5 ... 40 °C ²⁾ at relative air humidity 5 ... 85 % without condensation
	in storage as per EN 61800-2, IEC 60721-3-1 class 1K3 and 1K4	+5 ... 40 °C ²⁾ at relative air humidity 5 ... 85 % without condensation
	in transit as per EN 61800-2, IEC 60721-3-2 class 2K3	-25 ... +55 °C ³⁾ at air relative humidity 5 ... 95 %
Protection	Device	IP20 (terminals IP00)
	Cooling method	Convection
Protection against direct contact		BGV A3
Type of mounting	Built-in unit only for mounting vertically in a cabinet with min. ingress protection IP4x, on the usage of the STO safety function min. IP54	
Mounting height	up to 1000 m above zero level, at altitudes higher than 1000 m above zero level with power reduction, max. 2000 m above zero level	

Vibration limit in transit, as per EN 61800-2, IEC 60721-3-2 class 2M1

Frequency	Amplitude	Acceleration
2 < f < 9 Hz	3.5 mm	Not applicable
9 < f < 200 Hz	Not applicable	10 m/s ²
200 < f < 500 Hz	Not applicable	15 m/s ²

Shock limit in transit as per EN 61800-2, IEC 60721-2-2 class 2M1

Drop height of packed device max. 0.25 m

Vibration limit of the system⁵⁾, as per EN 61800-2, IEC 60721-3-3 class 3M1

Frequency	Amplitude	Acceleration
2 < f < 9 Hz	0.3 mm	Not applicable
9 < f < 200 Hz	Not applicable	1 m/s ²

- 2) The absolute humidity is limited to max. 25 g/m³. That means that the maximum values for temperature and relative air humidity stipulated in the table must not occur simultaneously.
- 3) The absolute humidity is limited to max. 25 g/m³. So the maximum values for temperature and relative air humidity stipulated in the table must not occur simultaneously.
- 4) The absolute humidity is limited to max. 60 g/m³. This means, at 70 °C for example, that the relative humidity may only be max. 40 %.
- 5) The devices are only designed for stationary use.

A.3 UL-Certification

The description of all measures to maintain UL approbation is to be found in the document „UL-Certification“ (ID No: 0927.01B.X.xx).

1

2

3

4

5

ADE
EN
FR
IT

Electrical isolation concept CDF3000

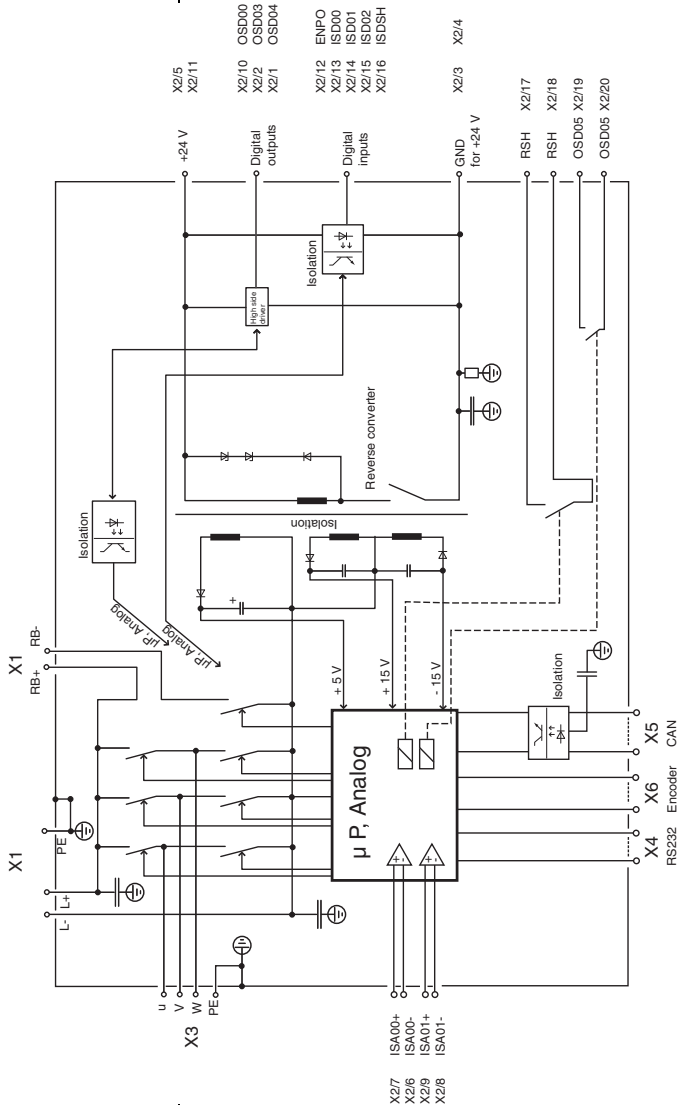

Fig. A.1 It is only allowed to lay signals and voltages to the CDF that meet the requirements for a protective extra-low voltage (PELV) or safety extra-low voltage (SELV) in the context of EN 61800-5-1. The related specifications and connection conditions for the signals and voltages must comply with the descriptions in the operation manual.

Appendix B Index**A**

Additional notes on safety for function "Safe Stop"
..... 3-20

B

Braking resistor 3-18

C

Connection of power supply units 3-5
Connection overview DC-mains supply 3-5
Control connections 3-30, 3-31

D

Danger (symbols) 1-2
Dangers 1-1
Digital Scope function 4-18
Disconnect 4-23
Display KP200 5-2
DriveManager-Icon 4-23

E

EMC (Electromagnetic Compatibility) 1-2
EMC directive 1-3
Emergency Stop facility 1-3
Encoder connection 3-10
ENPO 3-30, 4-17
Error messages 5-2

F

Factory setting 5-5
Feather key 4-16

H

H1 flash code 5-2
Holding brake
 plug-in connection 3-10

I

Inputs
 Specification 3-25, 3-31

K

KeyPad 4-20
KeyPad operation 4-20

L

LED 5-1
LEDs 5-1
LEDs (H1,H2,H3) 5-1
Logic table for Safe Standstill 3-27
Low voltage directive 1-3

M

Measures for your safety 1-1
Motor connection 3-9
Motor temp. monit. PTC 3-12
Multi-axis interconnection 3-17

O

Outputs
 Specification 3-31
Overview 3-3
 KeyPad 4-20
Overview of the connections CDB3000 3-22

P

Pin assignment of the serial interface X4 3-14
Power choke 3-16
Power stage enable 4-17
Project planning notes on the encoder connection
 3-13

Q

Qualification, user 1-2

KEBA**R**

Re-initialization	5-5
Relay outputs	3-26, 3-32
Repairs	1-3
Reset	5-5
Reset, parameter	5-5
Resolver	3-10
Responsibility	1-3

S

Safety	1-1
Safety instructions "Safe Standstill"	3-20
Save dataset from unit to file	4-3
Serial commissioning of DriveManager	4-5
Serial commissioning with KeyPad	4-3
Service repair	5-3
Shaft end	4-16
Specification	
Control connections	3-31
Specification of interface X6	3-10
Standards	1-3
Step response	4-19

T

Technical data	A-2
Terminal box	3-12
Terminal X4	3-14
Test run	4-2, 4-17
Triggering condition	4-18

U

UL-Approbation	A-5
User errors in SmartCard operation	5-4
User errors KP200	5-4

V

Voltage supply, specification	3-26, 3-33
-------------------------------------	------------

W

Wire cross-section	3-8
Wiring and commissioning	3-26

Notes on EN 61000-3-2 DE	Notes on EN 61000-3-2 EN
<p>(load on the mains due to harmonics)</p> <p>Our positioning drives and servo controllers are "professional equipment" in the context of EN61000 such that with a nominal connected load $\leq 1\text{kW}$ they fall within the scope of the standard. On the direct connection of drive units $\leq 1\text{kW}$ to the public low voltage grid, either measures to conform with the standard are to be taken or the responsible utility must grant approval for connection.</p> <p>If you should use our drive units as a component in your machine / system, then the scope of the standard is to be checked for the complete machine / system.</p>	<p>(limits for harmonic current emissions)</p> <p>Our frequency inverters and servocontrollers are "professional devices" in the sense of the European Standard EN 61000, and with a rated power of $\leq 1\text{kW}$ obtained in the scope of this standard.</p> <p>Direct connection of drive units $\leq 1\text{kW}$ to the public low-voltage grid only either by means of measurements for keeping the standard or via an authorization of connection from the responsible public utility.</p> <p>In case our drive units are used as a component of a machinery/plant, so the appropriate scope of the standard of the machinery/plant must be checked.</p>

Fit for the future with bundled competencies

KEBA is an internationally successful electronics business based in Linz/Austria with subsidiaries worldwide. Based on the motto "Automation by innovation." KEBA has for 50 years developed and manufactured innovative automation solutions of the highest quality for a very wide range of sectors.

www.keba.com

KEBA Industrial Automation Germany GmbH

Gewerbestr. 5-9, 35633 Lahnau/Germany

Telephone: +49 6441 966-0, fax: +49 6441 966-137, info@keba.de

KEBA Group worldwide

China • Germany • India • Italy • Japan • Netherlands

Austria • Romania • Switzerland • South Korea • Taiwan

Czech Republic • Turkey • USA

Copyright © KEBA 2021 All rights reserved.

All content of the documentation, in particular the text, photographs and graphics it contains are protected by copyright. The copyright lies, unless otherwise expressly stated, with KEBA Industrial Automation Germany GmbH.